

# IGBT - Field Stop 600 V, 40 A

## FGH40N60SMD-F085

### Description

Using Novel Field Stop IGBT Technology, ON Semiconductor's new series of Field Stop IGBTs offer the optimum performance for Automotive Chargers, Inverter, and other applications where low conduction and switching losses are essential.

### Features

- Maximum Junction Temperature:  $T_J = 175^\circ\text{C}$
- Positive Temperature Co-efficient for Easy Parallel Operating
- High Current Capability
- Low Saturation Voltage:  $V_{CE(sat)} = 1.9\text{ V(Typ.) @ } I_C = 40\text{ A}$
- High Input Impedance
- Tightened Parameter Distribution
- AEC Qualified and PPAP Capable  
IGBT: AEC-Q101
- This Device is Pb-Free and is RoHS Compliant

### Applications

- Automotive Chargers, Converters, High Voltage Auxiliaries
- Inverters, SMPS, PFC, UPS

### ABSOLUTE MAXIMUM RATINGS

Rating	Symbol	Ratings	Unit
Collector to Emitter Voltage	$V_{CES}$	600	V
Gate to Emitter Voltage	$V_{GES}$	$\pm 20$	V
Collector Current @ $T_c = 25^\circ\text{C}$ @ $T_c = 100^\circ\text{C}$	$I_C$	80 40	A
Pulsed Collector Current	$I_{CM}$ (Note 1)	120	A
Diode Forward Current @ $T_c = 25^\circ\text{C}$ @ $T_c = 100^\circ\text{C}$	$I_F$	40 20	A
Pulsed Diode Maximum Forward Current	$I_{FM}$ (Note 1)	120	A
Maximum Power Dissipation @ $T_c = 25^\circ\text{C}$ @ $T_c = 100^\circ\text{C}$	$P_D$	349 174	W
Operating Junction Temperature	$T_J$	$-55$ to $+175$	$^\circ\text{C}$
Storage Temperature Range	$T_{stg}$	$-55$ to $+175$	$^\circ\text{C}$
Maximum Lead Temperature for Soldering, 1/8" from Case for 5 Seconds	$T_L$	300	$^\circ\text{C}$

Stresses exceeding those listed in the Maximum Ratings table may damage the device. If any of these limits are exceeded, device functionality should not be assumed, damage may occur and reliability may be affected.

1. Repetitive rating: Pulse width limited by max. junction temperature.



**ON Semiconductor®**

[www.onsemi.com](http://www.onsemi.com)

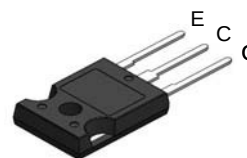
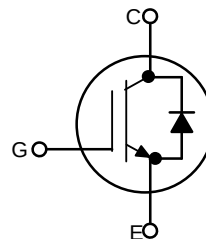

TO-247-3LD  
CASE 340CK

### MARKING DIAGRAM

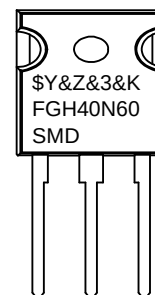

\$Y = ON Semiconductor Logo  
 &Z = Assembly Plant Code  
 &3 = Numeric Date Code  
 &K = Lot Code  
 FGH40N60SMD = Specific Device Code

### ORDERING INFORMATION

See detailed ordering and shipping information on page 2 of this data sheet.

# FGH40N60SMD-F085

## THERMAL CHARACTERISTICS

Parameter	Symbol	Rated	Unit
Thermal Resistance Junction-to-Case, for IGBT	$R_{JC}$ (Note 2)	0.43	$^{\circ}\text{C/W}$
Thermal Resistance Junction-to-Case, for Diode	$R_{JC}$	1.8	$^{\circ}\text{C/W}$
Parameter	Symbol	Typ.	
Thermal Resistance Junction-to-Ambient (PCB Mount) (Note 2)	$R_{JA}$	45	$^{\circ}\text{C/W}$

2.  $R_{JC}$  for TO-247: according to Mil standard 883-1012 test method.  $R_{JA}$  for TO-247: according to JESD51-2, test method environmental condition and JESD51-10, test boards for through hole perimeter leaded package thermal measurements. JESD51-3: Low Effective Thermal Conductivity Test Board for Leaded Surface Mount Package.

## PACKAGE MARKING AND ORDERING INFORMATION

Device Marking	Device	Package	Package Type	Quantity
FGH40N60SMD	FGH40N60SMD-F085	TO-247-3	Tube	30 Units

## ELECTRICAL CHARACTERISTICS OF THE IGBT ( $T_C = 25^{\circ}\text{C}$ unless otherwise noted)

Parameter	Symbol	Test Conditions	Min	Typ	Max	Unit
-----------	--------	-----------------	-----	-----	-----	------

### OFF CHARACTERISTICS

Collector to Emitter Breakdown Voltage	$BV_{CES}$	$V_{GE} = 0\text{ V}, I_C = 250\text{ A}$	600	-	-	V
Temperature Coefficient of Breakdown Voltage	$BV_{CES}/T_J$	$V_{GE} = 0\text{ V}, I_C = 250\text{ A}$	-	0.6	-	$V/^{\circ}\text{C}$
Collector Cut-Off Current	$I_{CES}$	$V_{CE} = V_{CES}, V_{GE} = 0\text{ V}$	-	-	250	A
		$I_{CES}$ at 80% * $BV_{CES}, 175^{\circ}\text{C}$	-	-	800	
G-E Leakage Current	$I_{GES}$	$V_{GE} = V_{GES}, V_{CE} = 0\text{ V}$	-	-	$\pm 400$	nA

### ON CHARACTERISTICS

G-E Threshold Voltage	$V_{GE(th)}$	$I_C = 250\text{ A}, V_{CE} = V_{GE}$	3.5	4.5	6.0	V
Collector to Emitter Saturation Voltage	$V_{CE(sat)}$	$I_C = 40\text{ A}, V_{GE} = 15\text{ V}$	-	1.9	2.5	V
		$I_C = 40\text{ A}, V_{GE} = 15\text{ V}, T_C = 175^{\circ}\text{C}$	-	2.1	-	V

### DYNAMIC CHARACTERISTICS

Input Capacitance	$C_{ies}$	$V_{CE} = 30\text{ V}, V_{GE} = 0\text{ V}, f = 1\text{ MHz}$	-	1880	2500	pF
Output Capacitance	$C_{oes}$		-	180	240	pF
Reverse Transfer Capacitance	$C_{res}$		-	50	65	pF

### SWITCHING CHARACTERISTICS

Turn-On Delay Time	$t_{d(on)}$	$V_{CC} = 400\text{ V}, I_C = 40\text{ A}, R_G = 6\ \Omega, V_{GE} = 15\text{ V},$ Inductive Load, $T_C = 25^{\circ}\text{C}$	-	18	24	ns
Rise Time	$t_r$		-	28	36.4	ns
Turn-Off Delay Time	$t_{d(off)}$		-	110	143	ns
Fall Time	$t_f$		-	13.2	18.5	ns
Turn-On Switching Loss	$E_{on}$		-	0.92	1.2	mJ
Turn-Off Switching Loss	$E_{off}$		-	0.3	0.39	mJ
Total Switching Loss	$E_{ts}$		-	1.22	1.59	mJ
Turn-On Delay Time	$t_{d(on)}$	$V_{CC} = 400\text{ V}, I_C = 40\text{ A}, R_G = 6\ \Omega, V_{GE} = 15\text{ V},$ Inductive Load, $T_C = 175^{\circ}\text{C}$	-	16.7	23.8	ns
Rise Time	$t_r$		-	27	35.1	ns
Turn-Off Delay Time	$t_{d(off)}$		-	116	151	ns
Fall Time	$t_f$		-	56.5	81	ns
Turn-On Switching Loss	$E_{on}$		-	1.47	1.91	mJ
Turn-Off Switching Loss	$E_{off}$		-	0.73	0.95	mJ
Total Switching Loss	$E_{ts}$		-	2.20	2.86	mJ

## FGH40N60SMD-F085

### ELECTRICAL CHARACTERISTICS OF THE IGBT ( $T_C = 25^\circ\text{C}$ unless otherwise noted) (continued)

Parameter	Symbol	Test Conditions	Min	Typ	Max	Unit
Total Gate Charge	$Q_g$	$V_{CE} = 400\text{ V}$ , $I_C = 40\text{ A}$ , $V_{GE} = 15\text{ V}$	-	119	180	nC
Gate to Emitter Charge	$Q_{ge}$		-	13	20	nC
Gate to Collector Charge	$Q_{gc}$		-	58	90	nC

### ELECTRICAL CHARACTERISTICS OF THE DIODE ( $T_J = 25^\circ\text{C}$ unless otherwise noted)

Parameter	Symbol	Test Conditions	Min	Typ	Max	Unit	
Diode Forward Voltage	$V_{FM}$	$I_F = 20\text{ A}$	$T_C = 25^\circ\text{C}$	-	2.3	2.8	V
			$T_C = 175^\circ\text{C}$	-	1.67	-	
Reverse Recovery Energy	$E_{rec}$	$I_F = 20\text{ A}$ , $di_F/dt = 200\text{ A/s}$	$T_C = 175^\circ\text{C}$	-	48.9	-	J
Diode Reverse Recovery Time	$t_{rr}$		$T_C = 25^\circ\text{C}$	-	36	47	ns
			$T_C = 175^\circ\text{C}$	-	110	-	
Diode Reverse Recovery Charge	$Q_{rr}$		$T_C = 25^\circ\text{C}$	-	46.8	61	nC
		$T_C = 175^\circ\text{C}$	-	470	-		

Product parametric performance is indicated in the Electrical Characteristics for the listed test conditions, unless otherwise noted. Product performance may not be indicated by the Electrical Characteristics if operated under different conditions.

TYPICAL CHARACTERISTICS

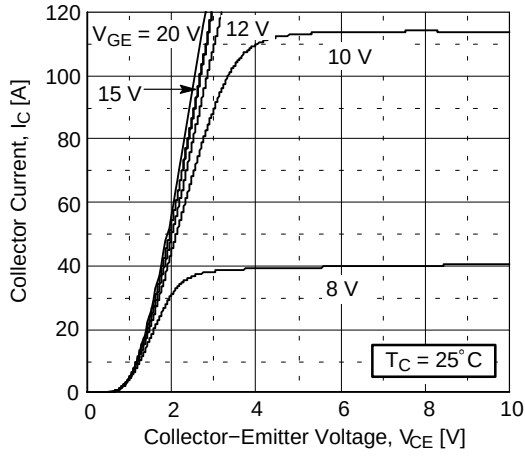

Figure 1. Typical Output Characteristics

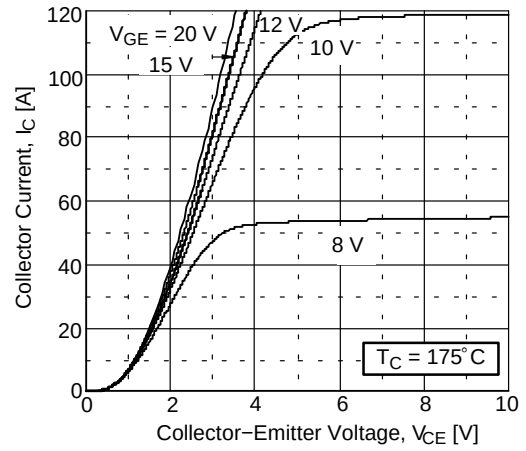

Figure 2. Typical Output Characteristics

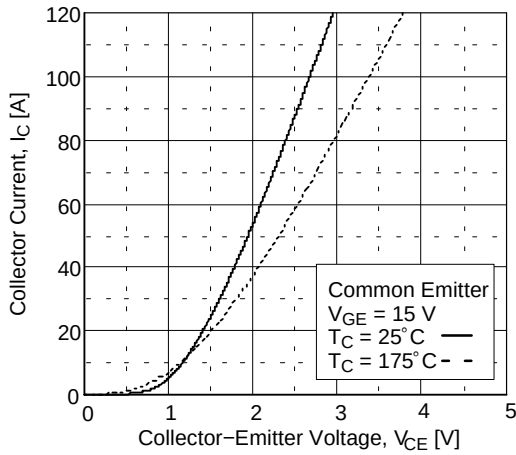

Figure 3. Typical Saturation Voltage Characteristics

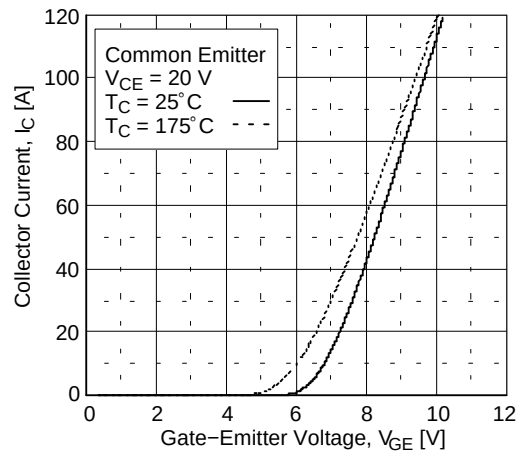

Figure 4. Transfer Characteristics

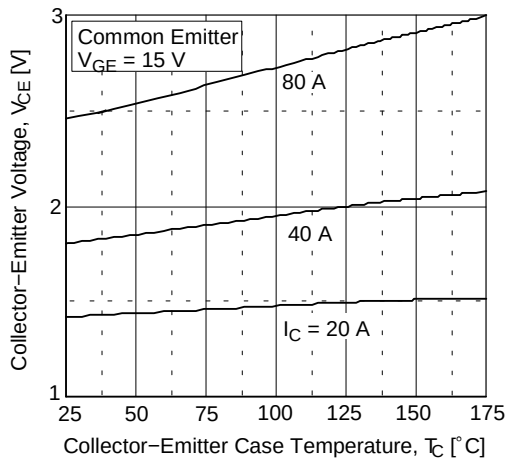

Figure 5. Saturation Voltage vs. Case Temperature at Variant Current Level

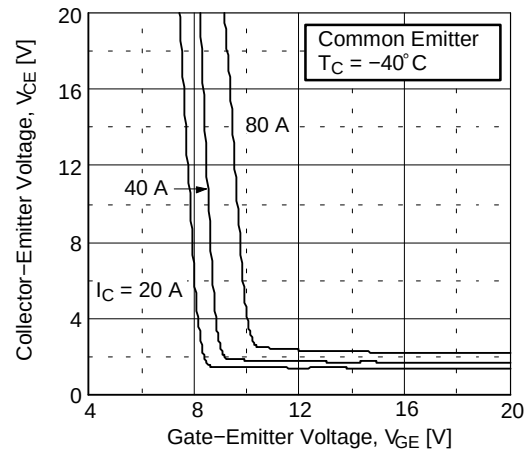

Figure 6. Saturation Voltage vs. Vge

TYPICAL CHARACTERISTICS

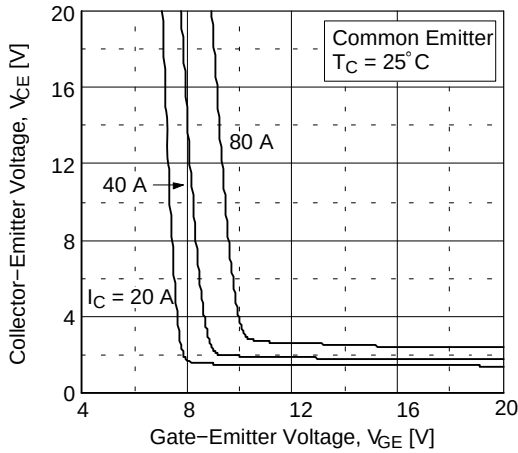

Figure 7. Saturation Voltage vs.  $V_{GE}$

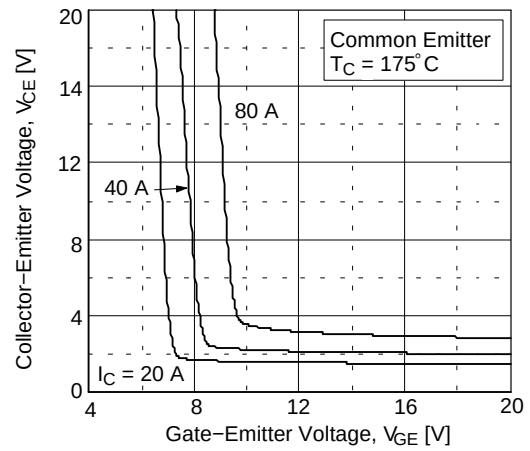

Figure 8. Saturation Voltage vs.  $V_{GE}$

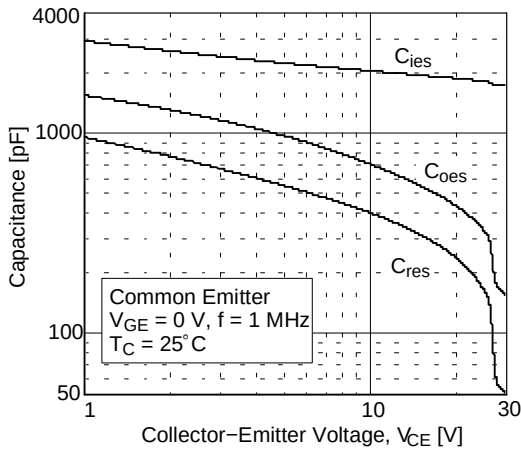

Figure 9. Capacitance Characteristics

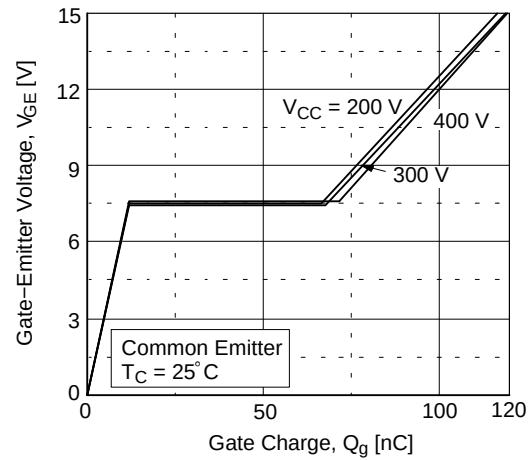

Figure 10. Gate Charge Characteristics

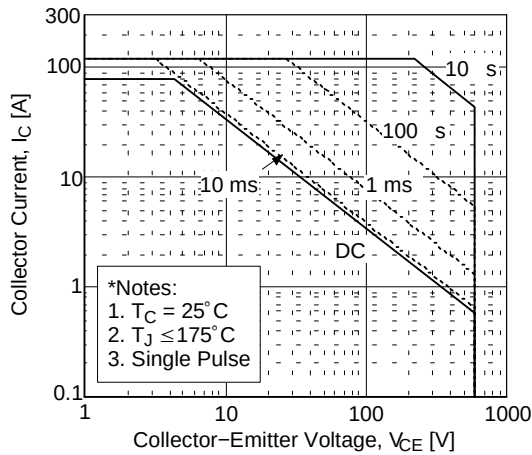

Figure 11. SOA Characteristics

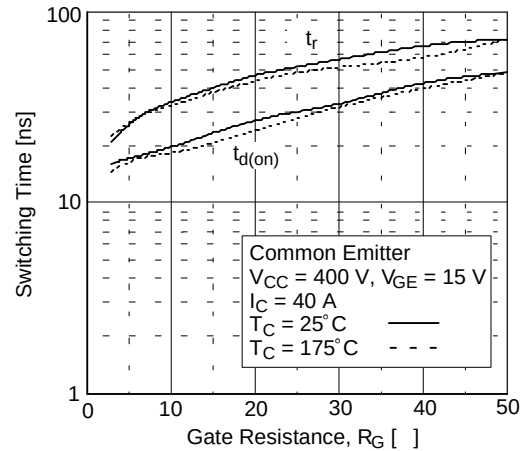

Figure 12. Turn-on Characteristics vs. Gate Resistance

TYPICAL CHARACTERISTICS

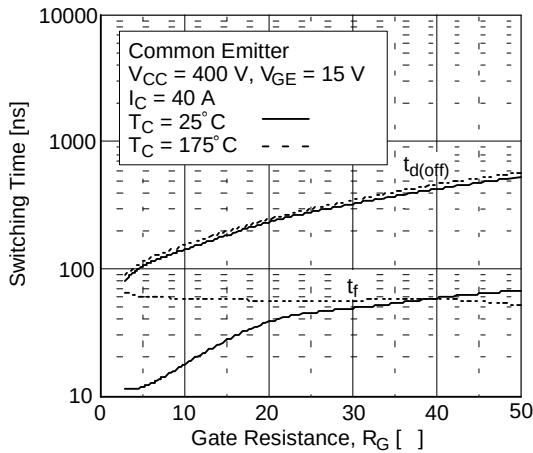

Figure 13. Turn-off Characteristics vs. Gate Resistance

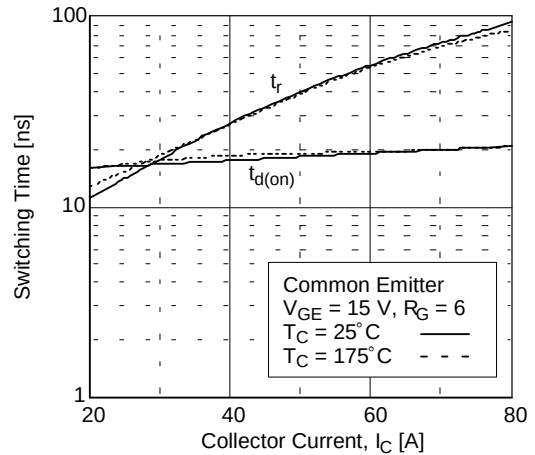

Figure 14. Turn-on Characteristics vs. Collector Current

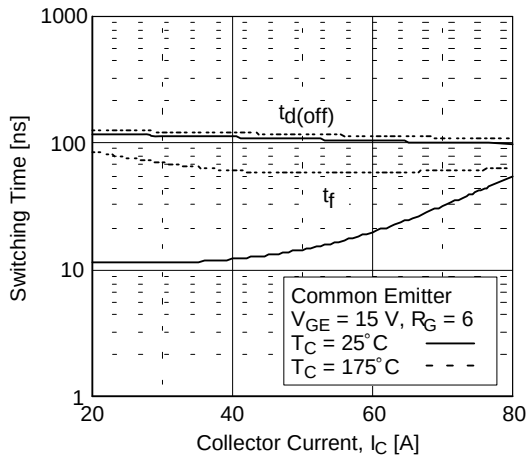

Figure 15. Turn-off Characteristics vs. Collector Current

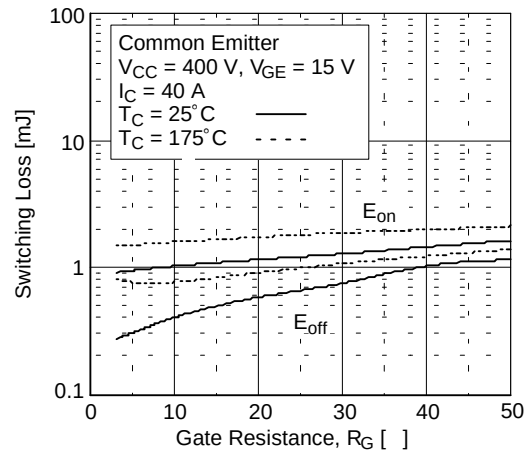

Figure 16. Switching Loss vs. Gate Resistance

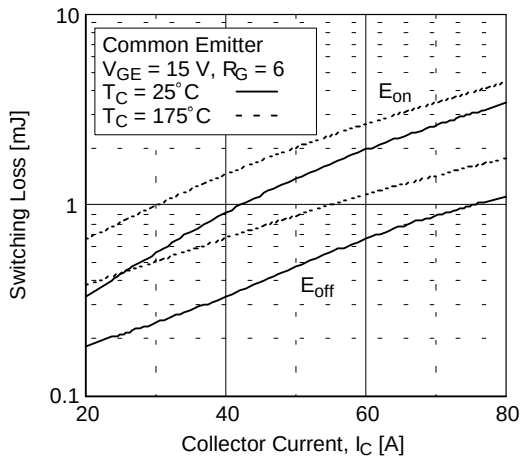

Figure 17. Switching Loss vs. Collector Current

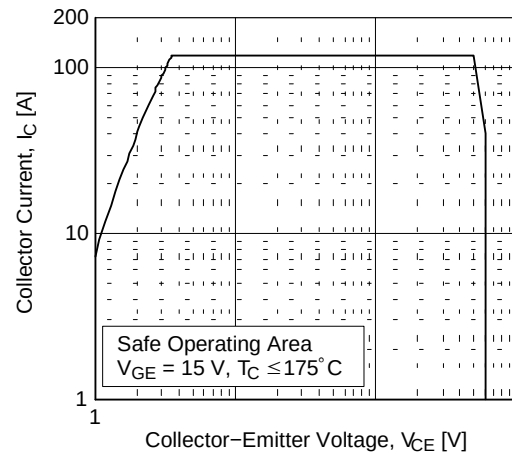

Figure 18. Turn-off Switching SOA Characteristics

TYPICAL CHARACTERISTICS

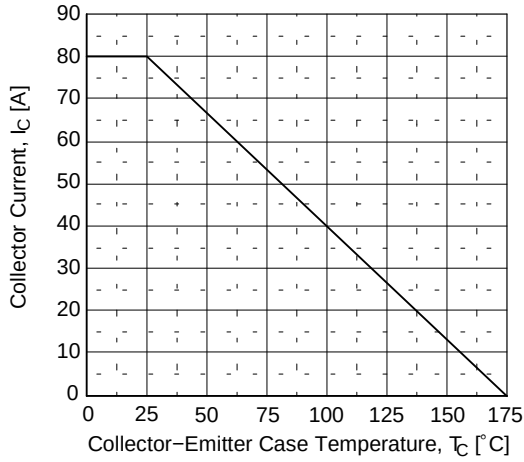

Figure 19. Current Derating

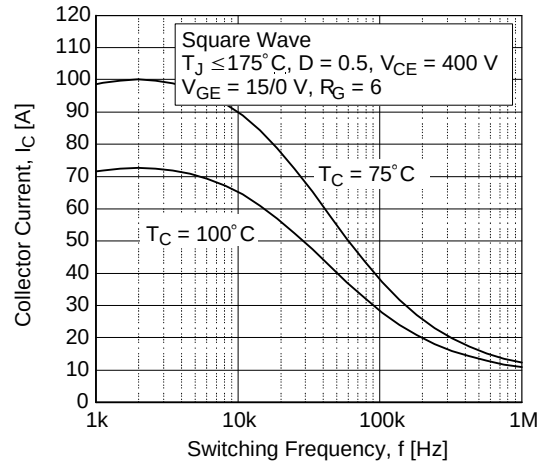

Figure 20. Load Current vs. Frequency

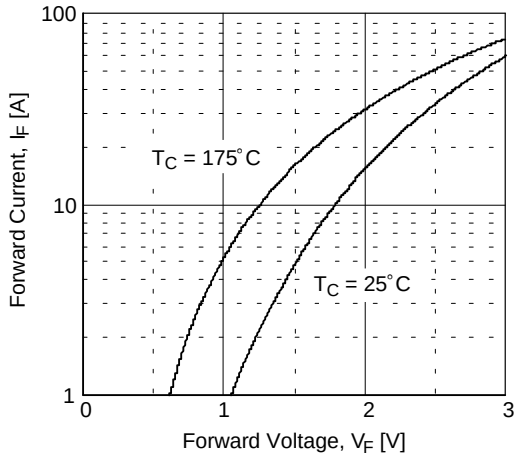

Figure 21. Forward Characteristics

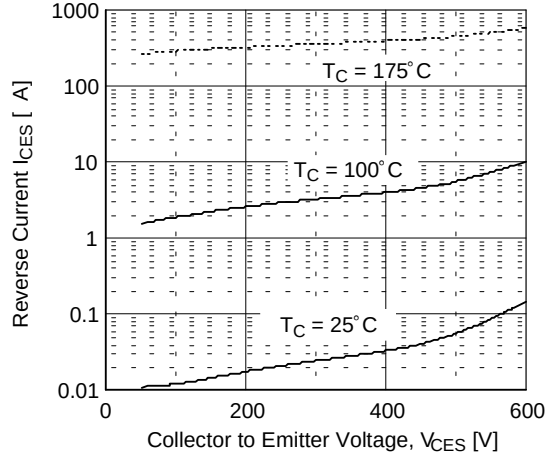

Figure 22. Reverse Current

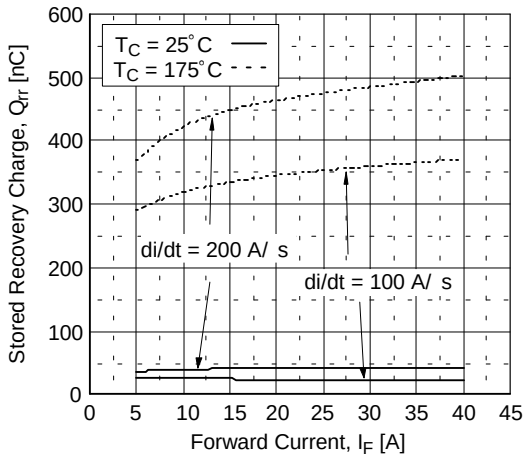

Figure 23. Stored Charge

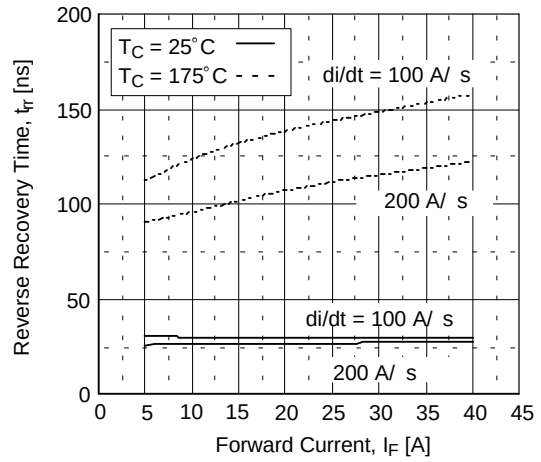

Figure 24. Reverse Recovery Time

# FGH40N60SMD-F085

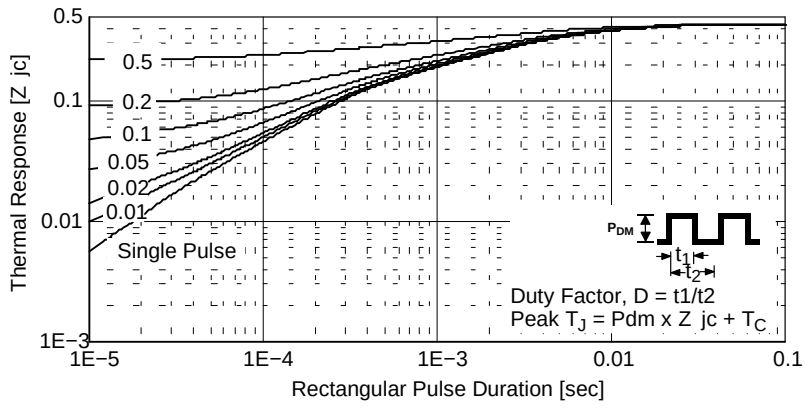

Figure 25. Transient Thermal Impedance of IGBT

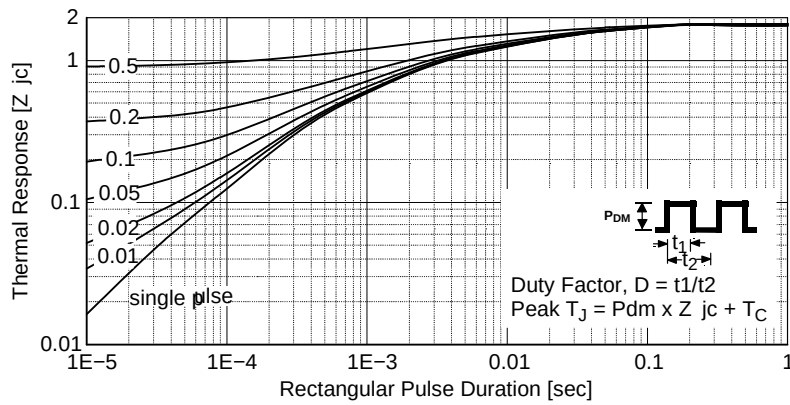
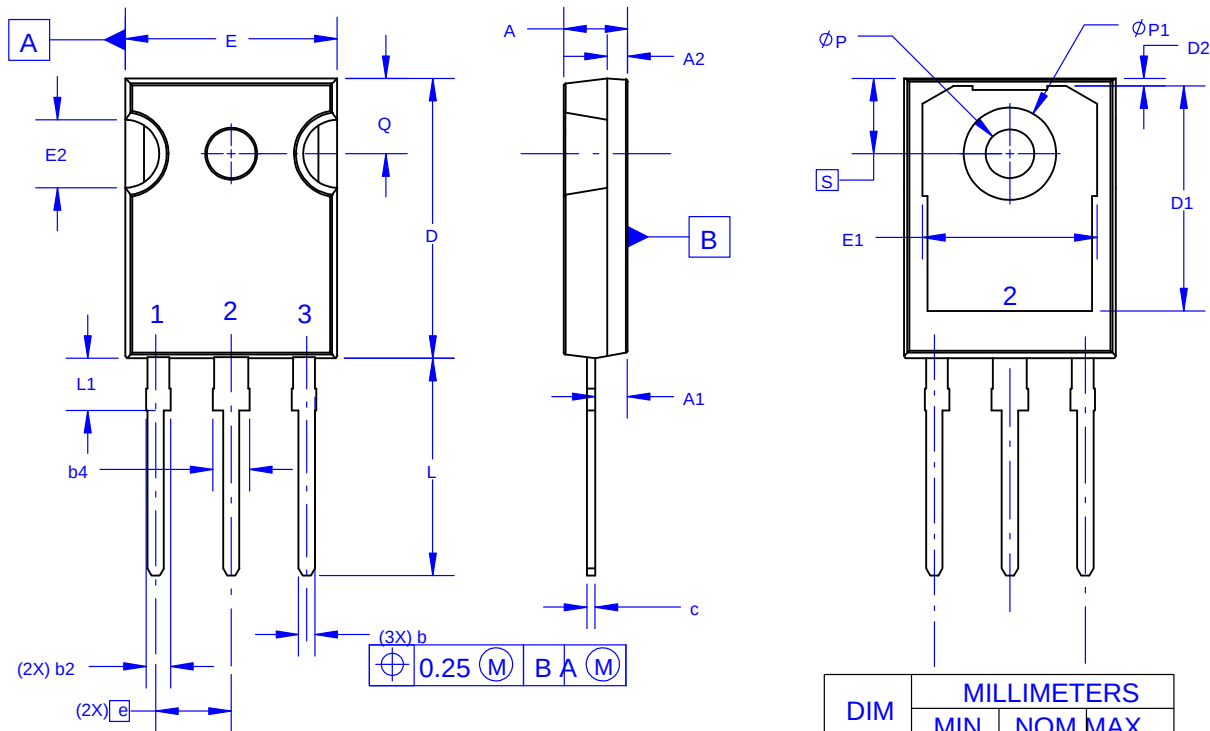

Figure 26. Transient Thermal Impedance of Diode



TO-247-3LD SHORT LEAD  
CASE 340CK  
ISSUE A

DATE 31 JAN 2019



NOTES: UNLESS OTHERWISE SPECIFIED.

- A. DIMENSIONS ARE EXCLUSIVE OF BURRS, MOLD FLASH, AND TIE BAR EXTRUSIONS.
- B. ALL DIMENSIONS ARE IN MILLIMETERS.
- C. DRAWING CONFORMS TO ASME Y14.5 - 2009.
- D. DIMENSION A1 TO BE MEASURED IN THE REGION DEFINED BY L1.
- E. LEAD FINISH IS UNCONTROLLED IN THE REGION DEFINED BY L1.

GENERIC  
MARKING DIAGRAM\*

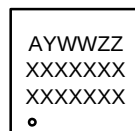

XXXX = Specific Device Code  
A = Assembly Location  
Y = Year  
WW = Work Week  
ZZ = Assembly Lot Code

\*This information is generic. Please refer to device data sheet for actual part marking. Pb-Free indicator, "G" or microdot "G", may or may not be present. Some products may not follow the Generic Marking.

DIM	MILLIMETERS		
	MIN	NOM	MAX
A	4.58	4.70	4.82
A1	2.20	2.40	2.60
A2	1.40	1.50	1.60
b	1.17	1.26	1.35
b2	1.53	1.65	1.77
b4	2.42	2.54	2.66
c	0.51	0.61	0.71
D	20.32	20.57	20.82
D1	13.08	~	~
D2	0.51	0.93	1.35
E	15.37	15.62	15.87
E1	12.81	~	~
E2	4.96	5.08	5.20
e	~	5.56	~
L	15.75	16.00	16.25
L1	3.69	3.81	3.93
ØP	3.51	3.58	3.65
ØP1	6.60	6.80	7.00
Q	5.34	5.46	5.58
S	5.34	5.46	5.58

DOCUMENT NUMBER:	98AON13851G	Electronic versions are uncontrolled except when accessed directly from the Document Repository. Printed versions are uncontrolled except when stamped "CONTROLLED COPY" in red.
DESCRIPTION:	TO-247-3LD SHORT LEAD	PAGE 1 OF 1

ON Semiconductor and are trademarks of Semiconductor Components Industries, LLC dba ON Semiconductor or its subsidiaries in the United States and/or other countries. ON Semiconductor reserves the right to make changes without further notice to any products herein. ON Semiconductor makes no warranty, representation or guarantee regarding the suitability of its products for any particular purpose, nor does ON Semiconductor assume any liability arising out of the application or use of any product or circuit, and specifically disclaims any and all liability, including without limitation special, consequential or incidental damages. ON Semiconductor does not convey any license under its patent rights nor the rights of others.

ON Semiconductor and  are trademarks of Semiconductor Components Industries, LLC dba ON Semiconductor or its subsidiaries in the United States and/or other countries. ON Semiconductor owns the rights to a number of patents, trademarks, copyrights, trade secrets, and other intellectual property. A listing of ON Semiconductor's product/patent coverage may be accessed at [www.onsemi.com/site/pdf/Patent-Marking.pdf](http://www.onsemi.com/site/pdf/Patent-Marking.pdf). ON Semiconductor reserves the right to make changes without further notice to any products herein. ON Semiconductor makes no warranty, representation or guarantee regarding the suitability of its products for any particular purpose, nor does ON Semiconductor assume any liability arising out of the application or use of any product or circuit, and specifically disclaims any and all liability, including without limitation special, consequential or incidental damages. Buyer is responsible for its products and applications using ON Semiconductor products, including compliance with all laws, regulations and safety requirements or standards, regardless of any support or applications information provided by ON Semiconductor. "Typical" parameters which may be provided in ON Semiconductor data sheets and/or specifications can and do vary in different applications and actual performance may vary over time. All operating parameters, including "Typicals" must be validated for each customer application by customer's technical experts. ON Semiconductor does not convey any license under its patent rights nor the rights of others. ON Semiconductor products are not designed, intended, or authorized for use as a critical component in life support systems or any FDA Class 3 medical devices or medical devices with a same or similar classification in a foreign jurisdiction or any devices intended for implantation in the human body. Should Buyer purchase or use ON Semiconductor products for any such unintended or unauthorized application, Buyer shall indemnify and hold ON Semiconductor and its officers, employees, subsidiaries, affiliates, and distributors harmless against all claims, costs, damages, and expenses, and reasonable attorney fees arising out of, directly or indirectly, any claim of personal injury or death associated with such unintended or unauthorized use, even if such claim alleges that ON Semiconductor was negligent regarding the design or manufacture of the part. ON Semiconductor is an Equal Opportunity/Affirmative Action Employer. This literature is subject to all applicable copyright laws and is not for resale in any manner.

## PUBLICATION ORDERING INFORMATION

### LITERATURE FULFILLMENT:

Email Requests to: [orderlit@onsemi.com](mailto:orderlit@onsemi.com)

ON Semiconductor Website: [www.onsemi.com](http://www.onsemi.com)

### TECHNICAL SUPPORT

North American Technical Support:  
Voice Mail: 1 800-282-9855 Toll Free USA/Canada  
Phone: 011 421 33 790 2910

Europe, Middle East and Africa Technical Support:

Phone: 00421 33 790 2910

For additional information, please contact your local Sales Representative