

Product description	M16 IP67 female angled connector, Contacts: 12, 4.0 - 6.0 mm, shieldable, solder, IP67, UL
Area	M16 IP67 series 423
Order number	99 5130 75 12

Illustration	Scale drawing	Contact arrangement (Plug-in side)

You can find the component part drawing and assembly instructions on the next page.

Technical data

General values

Connector design	female angled connector
Connector locking system	screw
Termination	solder
Wire gauge (mm)	max. 0.25 mm ²
Wire gauge (AWG)	max. AWG 24
Cable outlet	4.0 - 6.0 mm
Upper limit temperature	95 °C
Lower limit temperature	-30 °C
Customs tariff number	85369010

Electrical values

Rated current (40 °C)	3 A
Rated voltage	60 V
Rated impulse voltage	500 V
Pollution degree	1
Overvoltage category	I
Insulating material group	III
Insulation resistance	≥ 10 ¹⁰ Ω
EMC compliance	shieldable
Degree of protection	IP67
Mechanical operation	> 500 Mating cycles

Material

Contact material	CuSn (bronze)
Contact plating	Au (gold)
Contact body material	PBT (UL94 V-0)
REACH SVHC	CAS 96-45-7 (Imidazolidine-2-thione) CAS 7439-92-1 (Lead)

authorization/approvals

Approval 1	UL
------------	----

Product description **M16 IP67 female angled connector, Contacts: 12, 4.0 - 6.0 mm, shieldable, solder, IP67, UL**

Area **M16 IP67 series 423**

Order number **99 5130 75 12**

Component part drawing

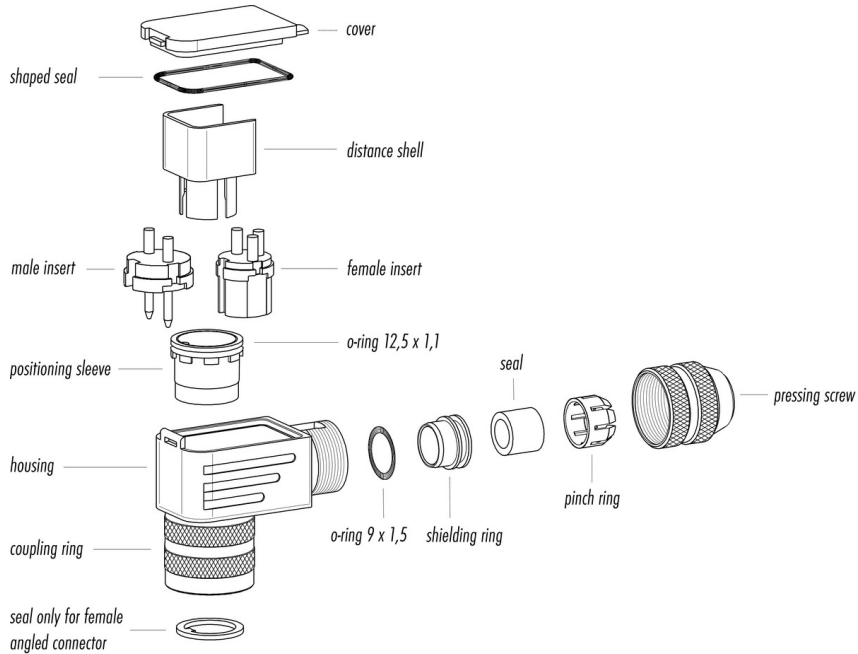

Assembly instructions / Panel cut-out

Angled version

1. Assemble sealing rings (3x).
2. Bead cable parts.
3. Dismantle cable and shielding braid.
4. Push single wires through housing.
5. Mount shielding ring and pinch ring.
6. Slightly fix pressing screw.
7. Solder wires to insert.
8. Mount positioning sleeve in angled position.
9. Put in insert and distance sleeve.
10. Mount lid.
11. Fix pressing screw (approx. 10-20 Nm).

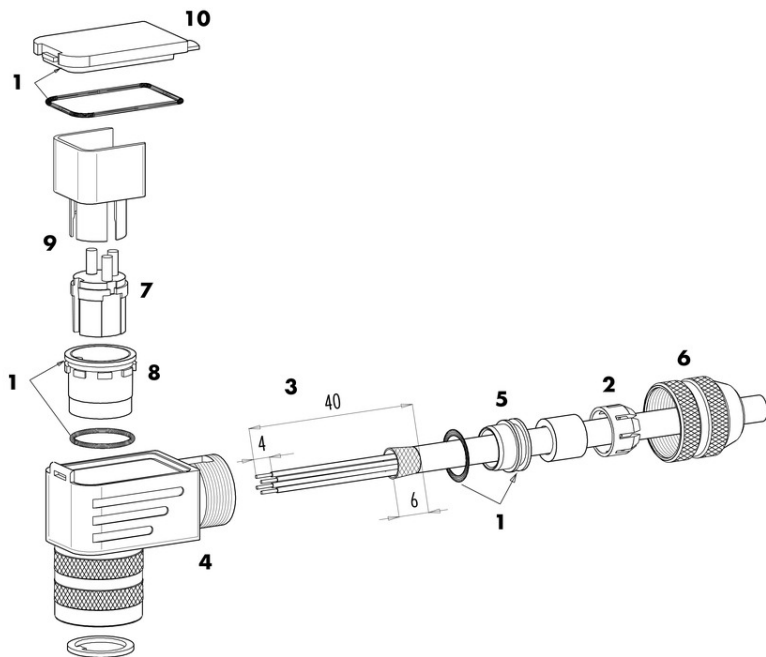

Product description	M16 IP67 female angled connector, Contacts: 12, 4.0 - 6.0 mm, shieldable, solder, IP67, UL
Area	M16 IP67 series 423
Order number	99 5130 75 12

Security notices

The connectors have been developed for applications in plant engineering, control and electrical equipment construction. The user is responsible for checking whether the connectors can also be used in other areas of application.

Plug connectors with enclosure protection IP 67 and IP 68 are not suitable for use under water. When used outdoors, the plug connectors must be protected separately against corrosion. For further information on the IP protection classes, please refer to the "Technical Information" download centre. To lock the cable connector with the device connector, the threaded ring is tightened "hand-tight" (approx. 50 cNm).