

Product description	M16 IP67 male cable connector, Contacts: 12, 6.0 - 8.0 mm, unshielded, solder, IP67
Area	M16 IP67 series 723
Order number	09 0129 70 12

Illustration	Scale drawing	Contact arrangement (Plug-in side)

You can find the component part drawing on the next page.

Technical data

General values

Connector design	male cable connector
Connector locking system	screw
Termination	solder
Wire gauge (mm)	0.25 mm ²
Wire gauge (AWG)	AWG 24
Cable outlet	6.0 - 8.0 mm
Upper limit temperature	95 °C
Lower limit temperature	-40 °C
Customs tariff number	85369010

Electrical values

Rated current (40 °C)	3 A
Rated voltage	60 V
Rated impulse voltage	500 V
Pollution degree	1
Overvoltage category	I
Insulating material group	III
Insulation resistance	≥ 10 ¹⁰ Ω
EMC compliance	unshielded
Degree of protection	IP67
Mechanical operation	> 500 Mating cycles

Material

Contact material	CuZn (brass)
Contact plating	Au (gold)
Contact body material	PBT (UL94 V-0)
Housing material	PA
REACH SVHC	CAS 7439-92-1 (Lead)

Product description M16 IP67 male cable connector, Contacts: 12, 6.0 - 8.0 mm, unshielded, solder, IP67

Area M16 IP67 series 723
Order number 09 0129 70 12

Component part drawing

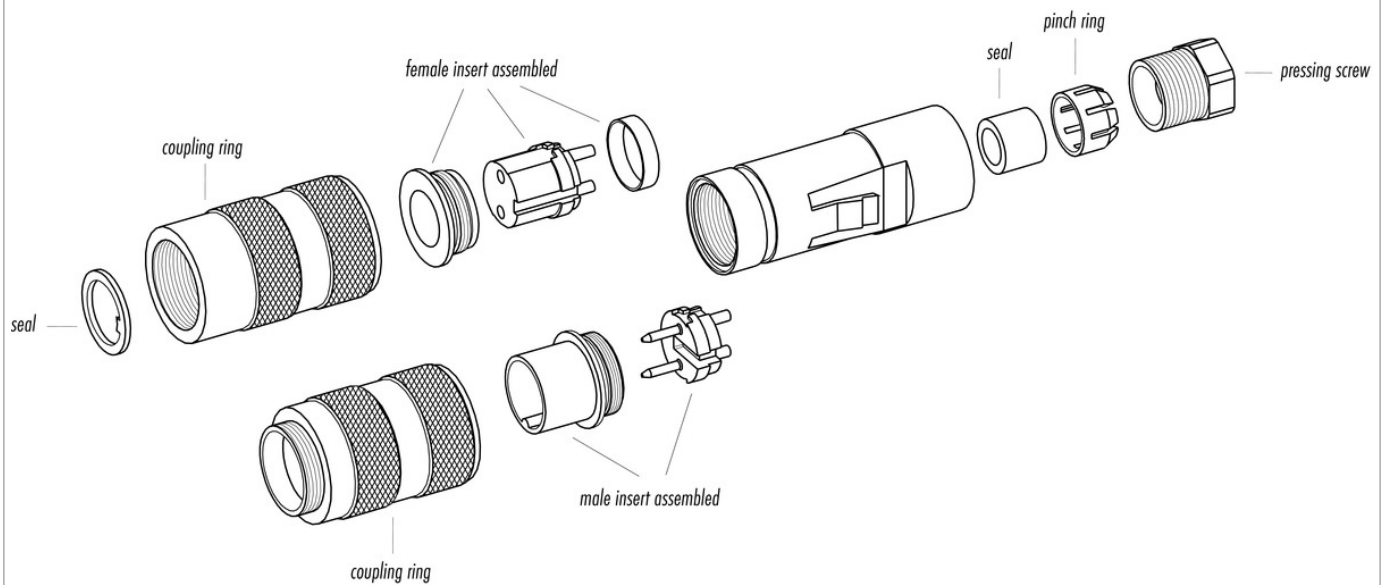

Product description	M16 IP67 male cable connector, Contacts: 12, 6.0 - 8.0 mm, unshielded, solder, IP67
Area	M16 IP67 series 723
Order number	09 0129 70 12

Security notices

The connectors have been developed for applications in plant engineering, control and electrical equipment construction. The user is responsible for checking whether the connectors can also be used in other areas of application.

Plug connectors with enclosure protection IP 67 and IP 68 are not suitable for use under water. When used outdoors, the plug connectors must be protected separately against corrosion. For further information on the IP protection classes, please refer to the "Technical Information" download centre. To lock the cable connector with the device connector, the threaded ring is tightened "hand-tight" (approx. 50 cNm).