

TP6KE Series

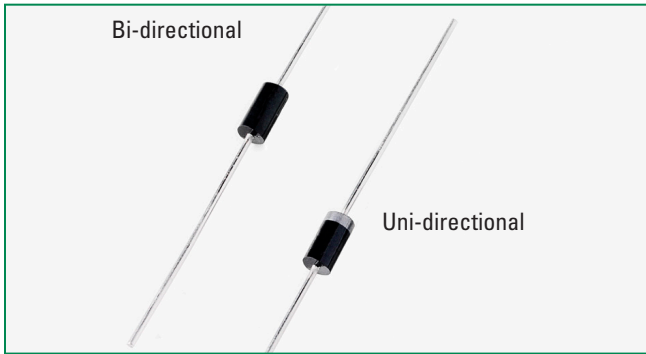

Agency Approvals

AGENCY	AGENCY FILE NUMBER
	E230531

Maximum Ratings and Thermal Characteristics (T_A=25°C unless otherwise noted)

Parameter	Symbol	Value	Unit
Peak Pulse Power Dissipation by 10/1000µs Test Waveform (Fig.2) (Note 1)	P _{PPM}	600	W
Steady State Power Dissipation on Infinite Heat Sink at T _L =75°C (Fig. 6)	P _D	5.0	W
Peak Forward Surge Current, 8.3ms Single Half Sine Wave Unidirectional Only (Note 2)	I _{FSM}	100	A
Maximum Instantaneous Forward Voltage at 50A for Unidirectional Only	V _F	3.5	V
Operating Junction and Storage Temperature Range	T _J , T _{STG}	-55 to 175	°C
Typical Thermal Resistance Junction to Lead	R _{uJL}	20	°C/W
Typical Thermal Resistance Junction to Ambient	R _{uJA}	75	°C/W

- Notes:**
1. Non-repetitive current pulse, per Fig. 4 and derated above T_J (initial) = 25°C per Fig. 3.
 2. Measured on 8.3ms single half sine wave or equivalent square wave, duty cycle=4 per minute maximum.

Functional Diagram

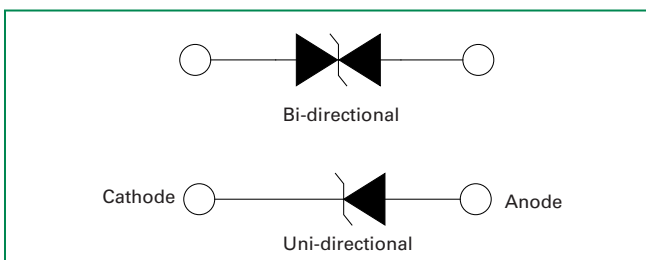

Description

The TP6KE series is specifically designed to protect sensitive electronic equipment from voltage transients induced by lightning and other transient voltage events.

Features

- Hi reliability application and automotive grade AEC-Q101 qualified
- Glass passivated chip junction in DO-15 Package
- 600W peak pulse capability at 10/1000µs waveform, repetition rate (duty cycles):0.01%
- Fast response time: typically less than 1.0ps from 0 Volts to BV min
- Excellent clamping capability
- Typical failure mode is short from over-specified voltage or current
- Whisker test is conducted based on JEDEC JESD201A per its table 4a and 4c
- IEC-61000-4-2 ESD 30kV(Air), 30kV (Contact)
- ESD protection of data lines in accordance with IEC 61000-4-2
- EFT protection of data lines in accordance with IEC 61000-4-4
- Low incremental surge resistance
- High temperature soldering guaranteed: 260°C+5/-0°C / 10s ±1sec / 0.375"/(9.5mm) lead length, 5 lbs., (2.3kg) tension
- V_{BR} @ T_J = V_{BR} @ 25°C x (1 + α T x (T_J - 25)) (α T: Temperature Coefficient, typical value is 0.1%)
- Plastic package is flammability rated V-0 per Underwriters Laboratories
- Lead-free matte tin plated package
- Halogen free and RoHS compliant
- Pb-free E3 means 2nd level interconnect is Pbfree and the terminal finish material is tin(Sn) (IPC/JEDEC J-STD-609A.01)

Applications

TVS devices are ideal for the protection of I/O interfaces, V_{CC} bus and other vulnerable circuits used in telecom, computer, industrial and consumer electronic applications.

Electrical Characteristics (T_A=25°C unless otherwise noted)

Part Number (Uni)	Part Number (Bi)	Reverse Stand off Voltage V _R (Volts)	Breakdown Voltage V _{BR} (Volts) @ I _T		Test Current I _T (mA)	Maximum Clamping Voltage V _C @ I _{pp} (V)	Maximum Peak Pulse Current I _{pp} (A)	Maximum Reverse Leakage I _R @ V _R (μA)	Agency Approval
			MIN	MAX					
TP6KE13A	TP6KE13CA	11.10	12.40	13.70	1	18.2	33.5	1	X
TP6KE15A	TP6KE15CA	12.80	14.30	15.80	1	21.2	28.8	1	X
TP6KE16A	TP6KE16CA	13.60	15.20	16.80	1	22.5	27.1	1	X
TP6KE18A	TP6KE18CA	15.30	17.10	18.90	1	25.2	24.2	1	X
TP6KE20A	TP6KE20CA	17.10	19.00	21.00	1	27.7	22.0	1	X
TP6KE22A	TP6KE22CA	18.80	20.90	23.10	1	30.6	19.9	1	X
TP6KE24A	TP6KE24CA	20.50	22.80	25.20	1	33.2	18.4	1	X
TP6KE27A	TP6KE27CA	23.10	25.70	28.40	1	37.5	16.3	1	X
TP6KE30A	TP6KE30CA	25.60	28.50	31.50	1	41.4	14.7	1	X
TP6KE33A	TP6KE33CA	28.20	31.40	34.70	1	45.7	13.3	1	X
TP6KE36A	TP6KE36CA	30.80	34.20	37.80	1	49.9	12.2	1	X
TP6KE39A	TP6KE39CA	33.30	37.10	41.00	1	53.9	11.3	1	X
TP6KE43A	TP6KE43CA	36.80	40.90	45.20	1	59.3	10.3	1	X
TP6KE47A	TP6KE47CA	40.20	44.70	49.40	1	64.8	9.4	1	X
TP6KE51A	TP6KE51CA	43.60	48.50	53.60	1	70.1	8.7	1	X
TP6KE56A	TP6KE56CA	47.80	53.20	58.80	1	77.0	7.9	1	X
TP6KE62A	TP6KE62CA	53.00	58.90	65.10	1	85.0	7.2	1	X
TP6KE68A	TP6KE68CA	58.10	64.60	71.40	1	92.0	6.6	1	X
TP6KE75A	TP6KE75CA	64.10	71.30	78.80	1	103.0	5.9	1	X
TP6KE82A	TP6KE82CA	70.10	77.90	86.10	1	113.0	5.4	1	X
TP6KE91A	TP6KE91CA	77.80	86.50	95.50	1	125.0	4.9	1	X

I-V Curve Characteristics

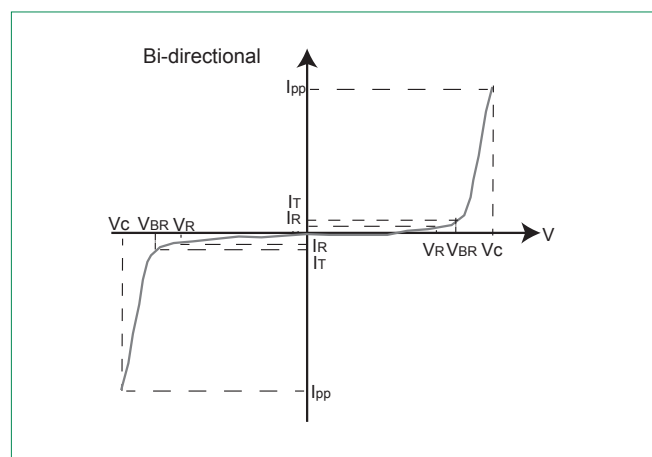
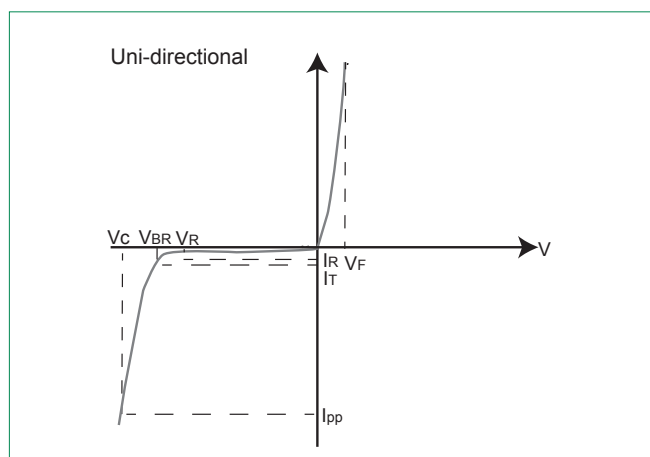

- P_{ppm} Peak Pulse Power Dissipation** – Max power dissipation
- V_R Stand-off Voltage** – Maximum voltage that can be applied to the TVS without operation
- V_{BR} Breakdown Voltage** – Maximum voltage that flows though the TVS at a specified test current (I_T)
- V_C Clamping Voltage** – Peak voltage measured across the TVS at a specified I_{ppm} (peak impulse current)
- I_R Reverse Leakage Current** – Current measured at V_R
- V_F Forward Voltage Drop for Uni-directional**

Ratings and Characteristic Curves ($T_A = 25^\circ\text{C}$ unless otherwise noted)

Figure 1 - TVS Transients Clamping Waveform

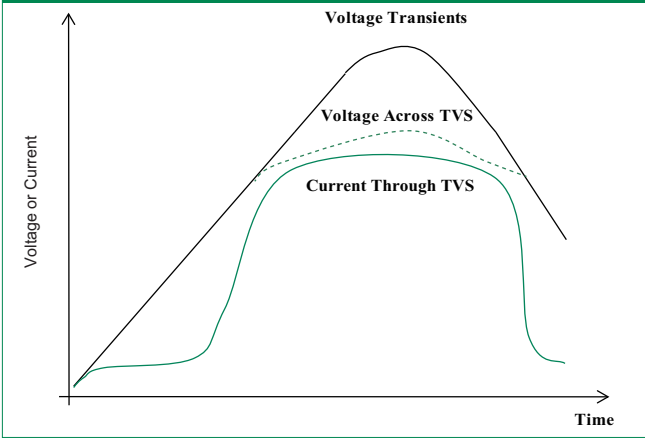

Figure 2 - Peak Pulse Power Rating

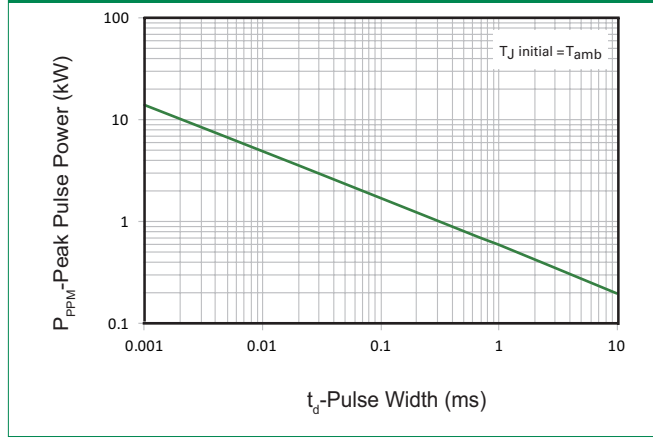

Figure 3 - Peak Pulse Power Derating Curve

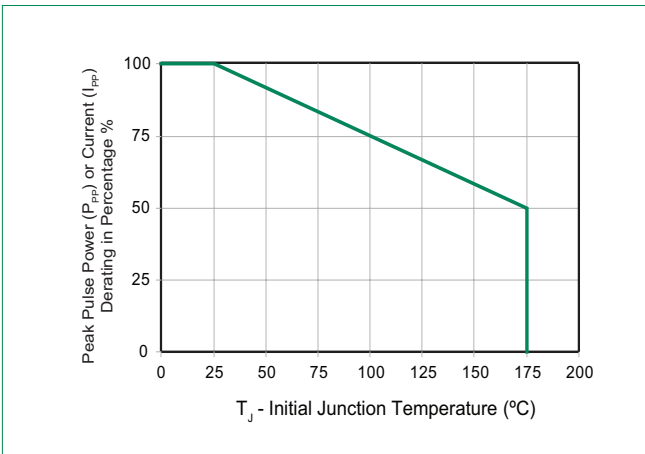

Figure 4 - Pulse Waveform

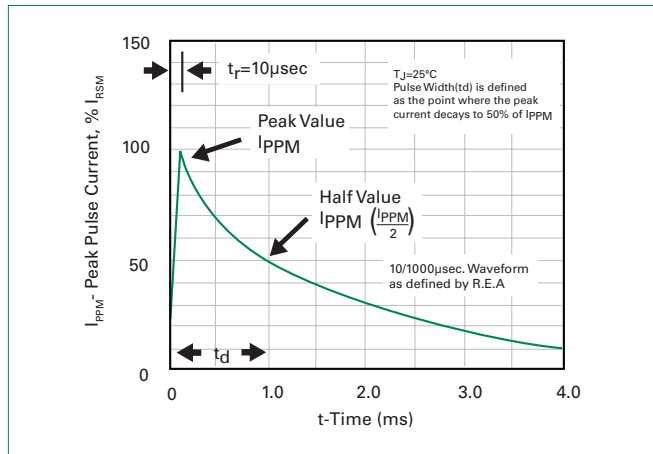

Figure 5 - Typical Junction Capacitance

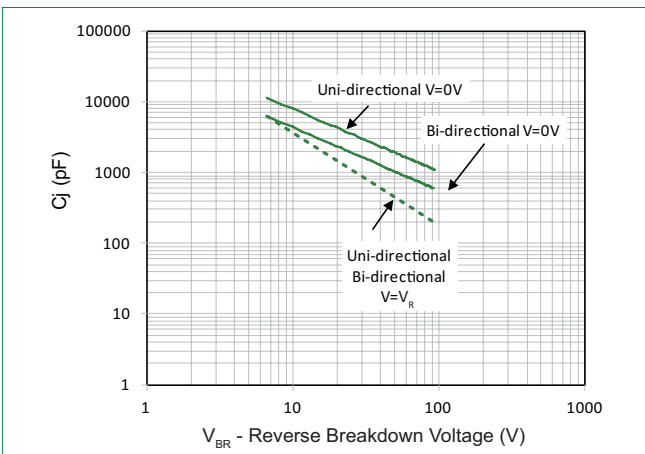

Figure 6 - Typical Transient Thermal Impedance

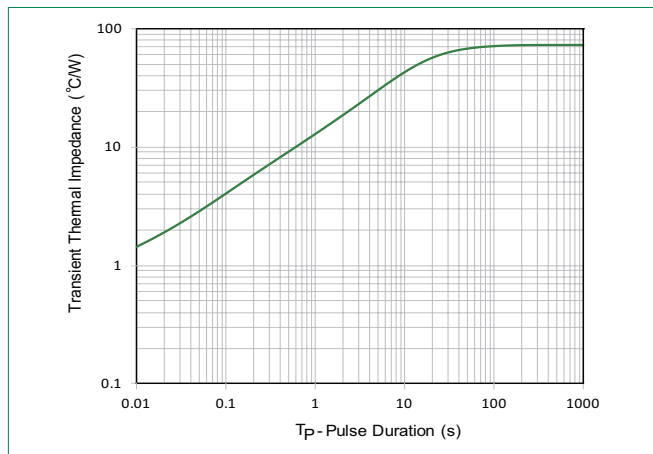
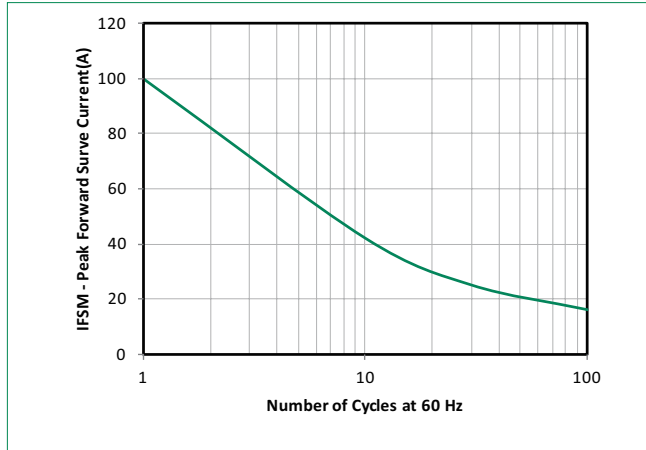

Figure 7 - Maximum Non-Repetitive Peak Forward Surge Current Uni-Directional Only



Flow/Wave Soldering (Solder Dipping)

Peak Temperature :	260°C+5/-0°C
Dipping Time :	10s ±1 seconds
Soldering :	1 time

Physical Specifications

Weight	0.015oz., 0.4g
Case	JEDEC DO-204AC (DO-15) molded plastic body over passivated junction.
Polarity	Color band denotes the cathode except Bipolar.
Terminal	Matte Tin axial leads, solderable per JESD22-B102.

Environmental Specifications

High Temp. Storage	JESD22-A103
HTRB	JESD22-A108
Temperature Cycling	JESD22-A104
H3TRB	JESD22-A101
RSH	JESD22-B106

Dimensions

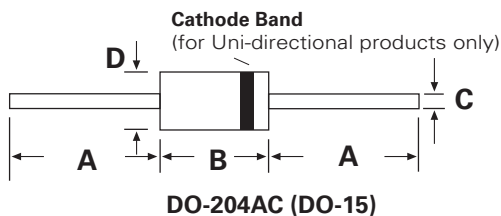

Dimensions	Inches		Millimeters	
	Min	Max	Min	Max
A	1.000	-	25.40	-
B	0.230	0.300	5.80	7.60
C	0.028	0.034	0.71	0.86
D	0.104	0.140	2.60	3.60

Part Numbering System

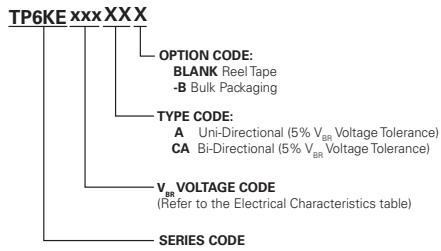

Part Marking System

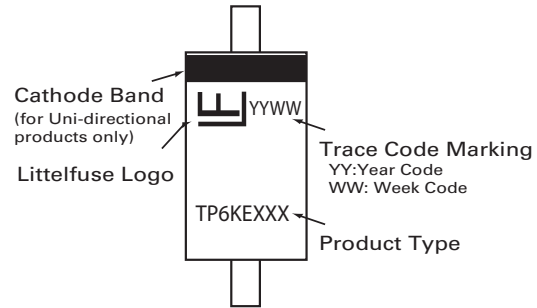

Packaging

Part Number	Component Package	Quantity	Packaging Option	Packaging Specification
TP6KExxxXX	DO-204AC	4000	Tape & Reel	EIA STD RS-296
TP6KExxxXX-B	DO-204AC	1000	BULK	Littelfuse Spec.

Tape and Reel Specification

