

# F93 Series



## Resin-Molded Chip, Standard Tantalum J-Lead



### FEATURES

- Compliant to the RoHS2 directive 2011/65/EU
- SMD J-lead

### APPLICATIONS

- Low power DC/DC



### CASE DIMENSIONS: millimeters (inches)

Code	EIA Code	EIA Metric	L	W <sub>1</sub>	W <sub>2</sub>	H	S
A	1206	3216-18	3.20 ± 0.20 (0.126 ± 0.008)	1.60 ± 0.20 (0.063 ± 0.008)	1.20 ± 0.10 (0.047 ± 0.004)	1.60 ± 0.20 (0.063 ± 0.008)	0.80 ± 0.20 (0.031 ± 0.008)
B	1210	3528-21	3.50 ± 0.20 (0.126 ± 0.008)	2.80 ± 0.20 (0.110 ± 0.008)	2.20 ± 0.10 (0.087 ± 0.004)	1.90 ± 0.20 (0.075 ± 0.008)	0.80 ± 0.20 (0.031 ± 0.008)
C	2312	6032-27	6.00 ± 0.20 (0.236 ± 0.008)	3.20 ± 0.20 (0.126 ± 0.008)	2.20 ± 0.10 (0.087 ± 0.004)	2.50 ± 0.20 (0.098 ± 0.008)	1.30 ± 0.20 (0.051 ± 0.008)
N	2917	7343-30	7.30 ± 0.20 (0.287 ± 0.008)	4.30 ± 0.20 (0.169 ± 0.008)	2.40 ± 0.10 (0.094 ± 0.004)	2.80 ± 0.20 (0.110 ± 0.008)	1.30 ± 0.20 (0.051 ± 0.008)

#### A, B CASE

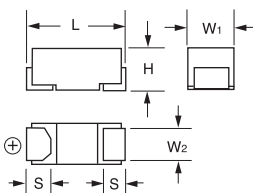

#### C, N CASE

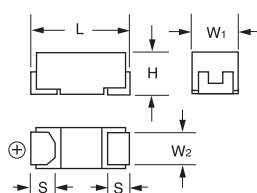

### MARKING

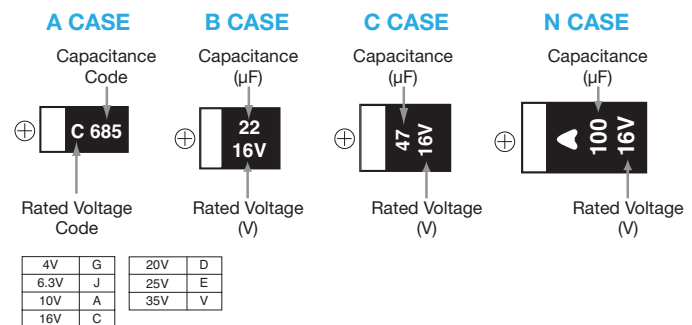

### HOW TO ORDER

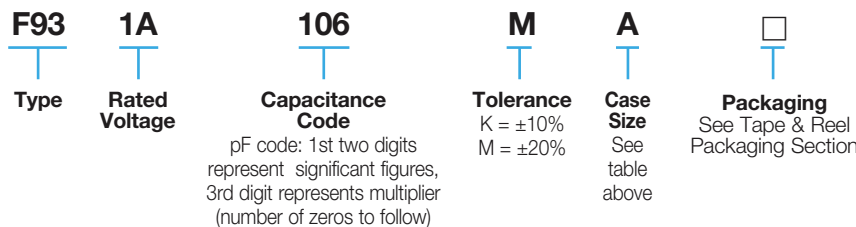

### TECHNICAL SPECIFICATIONS

Category Temperature Range:	-55 to +125°C
Rated Temperature:	+85°C
Capacitance Tolerance:	±20%, ±10% at 120Hz
Dissipation Factor:	Refer to next page
ESR 100kHz:	Refer to next page
Leakage Current:	After 1 minute's application of rated voltage, leakage current at 20°C is not more than 0.01CV or 0.5µA, whichever is greater. After 1 minute's application of rated voltage, leakage current at 85°C is not more than 0.1CV or 5µA, whichever is greater. After 1 minute's application of derated voltage, leakage current at 125°C is not more than 0.125CV or 6.3µA, whichever is greater.
Capacitance Change By Temperature	+15% Max. at +125°C +10% Max. at +85°C -10% Max. at -55°C

# F93 Series



## Resin-Molded Chip, Standard Tantalum J-Lead

### CAPACITANCE AND RATED VOLTAGE RANGE (LETTER DENOTES CASE SIZE)

Capacitance		Rated Voltage						
μF	Code	4V (0G)	6.3V (0J)	10V (1A)	16V (1C)	20V (1D)	25V (1E)	35V (1V)
0.68	684							A
1.0	105				A		A	A
1.5	155				A		A	A
2.2	225				A	A	A	A/B
3.3	335				A	A	A	B
4.7	475			A	A	A/B	A/B	B/C
6.8	685			A	A	A/B		C
10	106		A	A	A/B	A/B	B/C	C
15	156		A	A	A/B	C	C	N
22	226	A	A	A/B	A/B/C	B/C	C/N	N
33	336	A	A	A/B	B/C	C/N	N	N
47	476	A	A/B	A/B/C	B/C/N	C/N	N	
68	686	A	A/B	B/C	C/N	N*		
100	107	A/B	A/B/C	B/C/N	C/N			
150	157	B	B/C	C/N	N			
220	227	A*/B/C	B/C/N	C/N	N			
330	337	C	C*/N	N				
470	447	N	N					
680	687	N	N*					

Released ratings

\*Ratings under development – subject to change

Please contact to your local AVX sales office when these series are being designed in your application.

### RATINGS & PART NUMBER REFERENCE

AVX Part No.	Case Size	Capacitance (µF)	Rated Voltage (V)	DCL (µA)	DF @ 120Hz (%)	ESR @ 100kHz (Ω)	*1 ΔC/C (%)	MSL
<b>4 Volt</b>								
F930G226MAA	A	22	4	0.9	6	2.5	*	1
F930G336MAA	A	33	4	1.3	8	2.5	*	1
F930G476MAA	A	47	4	1.9	18	2.5	*	1
F930G686MAA	A	68	4	2.7	24	2.5	*	1
F930G107MAA	A	100	4	4.0	30	2.0	*	1
F930G107MBA	B	100	4	4.0	14	0.9	*	1
F930G157MBA	B	150	4	6.0	16	0.7	*	1
F930G227MBA	B	220	4	8.8	18	0.7	*	1
F930G227MCC	C	220	4	8.8	12	0.7	*	1
F930G337MCC	C	330	4	13.2	14	0.7	*	1
F930G477MNC	N	470	4	18.8	16	0.3	*	1
F930G687MNC	N	680	4	27.2	18	0.3	*	1
<b>6.3 Volt</b>								
F930J106MAA	A	10	6.3	0.6	6	3.0	*	1
F930J156MAA	A	15	6.3	0.9	6	2.9	*	1
F930J226MAA	A	22	6.3	1.4	8	2.5	*	1
F930J336MAA	A	33	6.3	2.1	8	2.5	*	1
F930J476MAA	A	47	6.3	3.0	18	2.5	*	1
F930J476MBA	B	47	6.3	3.0	6	1.0	*	1
F930J686MAA	A	68	6.3	4.3	20	2.0	*	1
F930J686MBA	B	68	6.3	4.3	8	1.0	*	1
F930J107MAA	A	100	6.3	6.3	35	2.0	±15	1
F930J107MBA	B	100	6.3	6.3	14	0.9	*	1
F930J107MCC	C	100	6.3	6.3	8	0.7	*	1
F930J157MBA	B	150	6.3	9.5	18	0.9	*	1
F930J157MCC	C	150	6.3	9.5	12	0.7	*	1
F930J227MBA	B	220	6.3	13.9	30	1.2	±15	3
F930J227MCC	C	220	6.3	13.9	14	0.7	*	1
F930J227MNC	N	220	6.3	13.9	10	0.5	*	1
F930J337MNC	N	330	6.3	20.8	14	0.5	*	1
F930J477MNC	N	470	6.3	29.6	16	0.3	*	1
<b>10 Volt</b>								
F931A475MAA	A	4.7	10	0.5	6	4.0	*	1
F931A685MAA	A	6.8	10	0.7	6	3.5	*	1
F931A106MAA	A	10	10	1.0	6	3.0	*	1
F931A156MAA	A	15	10	1.5	8	2.9	*	1
F931A226MAA	A	22	10	2.2	12	2.5	*	1
F931A226MBA	B	22	10	2.2	6	1.9	*	1
F931A336MAA	A	33	10	3.3	18	2.5	*	1
F931A336MBA	B	33	10	3.3	8	1.4	*	1
F931A476MAA	A	47	10	4.7	40	2.0	±15	1
F931A476MBA	B	47	10	4.7	8	1.0	*	1
F931A476MCC	C	47	10	4.7	6	0.9	*	1
F931A686MBA	B	68	10	6.8	12	0.9	±15	1
F931A686MCC	C	68	10	6.8	8	0.8	*	1
F931A107MBA	B	100	10	10.0	18	1.2	±15	1
F931A107MCC	C	100	10	10.0	10	0.7	*	1
F931A107MNC	N	100	10	10.0	8	0.6	*	3
F931A157MCC	C	150	10	15.0	14	0.7	*	1
F931A157MNC	N	150	10	15.0	10	0.6	*	1
F931A227MCC	C	220	10	22.0	40	0.9	±15	1
F931A227MNC	N	220	10	22.0	12	0.5	*	3
F931A337MNC	N	330	10	33.0	18	0.5	*	1
<b>16 Volt</b>								
F931C105MAA	A	1	16	0.5	4	7.5	*	1
F931C155MAA	A	1.5	16	0.5	4	6.0	*	1
F931C225MAA	A	2.2	16	0.5	4	5.0	*	1
F931C335MAA	A	3.3	16	0.5	4	4.5	*	1
F931C475MAA	A	4.7	16	0.8	6	4.0	*	1
F931C685MAA	A	6.8	16	1.1	6	3.5	*	1

\*1: ΔC/C Marked “\*”

Item	All Case (%)
Damp Heat	±10
Temperature cycles	±5
Resistance soldering heat	±5
Surge	±5
Endurance	±10

AVX Part No.	Case Size	Capacitance (µF)	Rated Voltage (V)	DCL (µA)	DF @ 120Hz (%)	ESR @ 100kHz (Ω)	*1 ΔC/C (%)	MSL
F931C106MAA	A	10	16	1.6	6	3.0	*	1
F931C106MBA	B	10	16	1.6	6	2.0	*	1
F931C156MAA	A	15	16	2.4	10	2.0	*	1
F931C156MBA	B	15	16	2.4	6	2.0	*	1
F931C226MAA	A	22	16	3.5	15	3.0	±15	1
F931C226MBA	B	22	16	3.5	8	1.9	*	1
F931C226MCC	C	22	16	3.5	6	1.1	*	1
F931C336MBA	B	33	16	5.3	8	1.9	*	1
F931C336MCC	C	33	16	5.3	6	1.1	*	1
F931C476MBA	B	47	16	7.5	16	2.0	±15	1
F931C476MCC	C	47	16	7.5	8	0.9	*	1
F931C476MNC	N	47	16	7.5	6	0.7	*	1
F931C686MCC	C	68	16	10.9	10	0.8	±10	1
F931C686MNC	N	68	16	10.9	6	0.6	*	1
F931C107MCC	C	100	16	16.0	15	0.7	±10	1
F931C107MNC	N	100	16	16.0	10	0.6	*	3
F931C157MNC	N	150	16	24.0	15	0.6	*	1
F931C227MNC	N	220	16	35.2	25	0.7	±10	3
<b>20 Volt</b>								
F931D225MAA	A	2.2	20	0.5	4	5.0	*	1
F931D335MAA	A	3.3	20	0.7	4	4.5	*	1
F931D475MAA	A	4.7	20	0.9	6	3.0	*	1
F931D475MBA	B	4.7	20	0.9	6	2.8	*	1
F931D685MAA	A	6.8	20	1.4	6	3.5	*	1
F931D685MBA	B	6.8	20	1.4	6	2.5	*	1
F931D106MAA	A	10	20	2.0	8	3.5	*	1
F931D106MBA	B	10	20	2.0	6	2.1	*	1
F931D156MCC	C	15	20	3.0	6	1.2	*	1
F931D226MBA	B	22	20	4.4	8	1.9	*	1
F931D226MCC	C	22	20	4.4	8	1.1	*	1
F931D336MCC	C	33	20	6.6	8	1.1	*	1
F931D336MNC	N	33	20	6.6	6	0.7	*	1
F931D476MCC	C	47	20	9.4	10	1.1	*	1
F931D476MNC	N	47	20	9.4	8	0.7	*	1
<b>25 Volt</b>								
F931E105MAA	A	1	25	0.5	4	7.5	*	1
F931E155MAA	A	1.5	25	0.5	4	6.7	*	1
F931E225MAA	A	2.2	25	0.6	6	6.3	*	1
F931E335MAA	A	3.3	25	0.8	6	6.0	*	1
F931E475MAA	A	4.7	25	1.2	8	4.0	*	1
F931E475MBA	B	4.7	25	1.2	6	2.8	*	1
F931E106MBA	B	10	25	2.5	12	1.9	*	1
F931E106MCC	C	10	25	2.5	6	1.5	*	1
F931E156MCC	C	15	25	3.8	8	1.2	*	1
F931E226MCC	C	22	25	5.5	8	1.1	*	1
F931E226MNC	N	22	25	5.5	6	0.7	*	1
F931E336MNC	N	33	25	8.3	8	0.7	*	1
F931E476MNC	N	47	25	11.8	8	0.7	*	1
<b>35 Volt</b>								
F931V684MAA	A	0.68	35	0.5	4	7.6	*	1
F931V105MAA	A	1	35	0.5	4	7.5	*	1
F931V155MAA	A	1.5	35	0.5	6	7.5	*	1
F931V225MAA	A	2.2	35	0.8	6	7.0	*	1
F931V225MBA	B	2.2	35	0.8	4	3.8	*	1
F931V335MBA	B	3.3	35	1.2	4	3.5	*	1
F931V475MBA	B	4.7	35	1.6	8	3.1	*	1
F931V475MCC	C	4.7	35	1.6	6	1.8	*	1
F931V685MCC	C	6.8	35	2.4	6	1.8	*	1
F931V106MCC	C	10	35	3.5	6	1.6	*	1
F931V156MNC	N	15	35	5.3	6	0.7	*	1
F931V226MNC	N	22	35	7.7	8	0.7	*	1
F931V336MNC	N	33	35	11.6	8	0.7	*	1

\* In case of capacitance tolerance ± 10% type, “K” will be put at 9th digit of type numbering system  
Moisture Sensitivity Level (MSL) is defined according to J-STD-020.

### QUALIFICATION TABLE

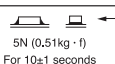
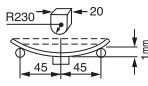
TEST	F93 series (Temperature range -55°C to +125°C)	
	Condition	
<b>Damp Heat (Steady State)</b>	At 40°C, 90 to 95% R.H., 500 hours (No voltage applied) Capacitance Change ..... Refer to page 32 (*1) Dissipation Factor ..... Initial specified value or less Leakage Current ..... Initial specified value or less	
<b>Temperature Cycles</b>	-55°C / +125°C, 30 minutes each, 5 cycles Capacitance Change ..... Refer to page 32 (*1) Dissipation Factor ..... Initial specified value or less Leakage Current ..... Initial specified value or less	
<b>Resistance to Soldering Heat</b>	10 seconds reflow at 260°C, 5 seconds immersion at 260°C. Capacitance Change ..... Refer to page 32 (*1) Dissipation Factor ..... Initial specified value or less Leakage Current ..... Initial specified value or less	
<b>Surge</b>	After application of surge voltage in series with a 33Ω resistor at the rate of 30 seconds ON, 30 seconds OFF, for 1000 successive test cycles at 85°C, capacitors shall meet the characteristic requirements in the table above. Capacitance Change ..... Refer to page 32 (*1) Dissipation Factor ..... Initial specified value or less Leakage Current ..... Initial specified value or less	
<b>Endurance</b>	After 2000 hours' application of rated voltage in series with a 3Ω resistor at 85°C, or derated voltage in series with a 3Ω resistor at 125°C, capacitors shall meet the characteristic requirements in the table above. Capacitance Change ..... Refer to page 32 (*1) Dissipation Factor ..... Initial specified value or less Leakage Current ..... Initial specified value or less	
<b>Shear Test</b>	After applying the pressure load of 5N for 10±1 seconds horizontally to the center of capacitor side body which has no electrode and has been soldered beforehand on a substrate, there shall be found neither exfoliation nor its sign at the terminal electrode.	 5N (0.51kg · f) For 10±1 seconds
<b>Terminal Strength</b>	Keeping a capacitor surface-mounted on a substrate upside down and supporting the substrate at both of the opposite bottom points 45mm apart from the center of capacitor, the pressure strength is applied with a specified jig at the center of substrate so that the substrate may bend by 1mm as illustrated. Then, there shall be found no remarkable abnormality on the capacitor terminals.	 R230 20 45 45 E
<b>Failure Rate</b>	1% per 1000 hours at 85°C, VR with 0.1Ω/V series impedance, 60% confidence level.	

We can supply the type of compliance to AEC-Q200. Please contact to your local AVX sales office when these series are being designed in your application.

### AVX SOLID ELECTROLYTE CAPACITOR ROADMAP

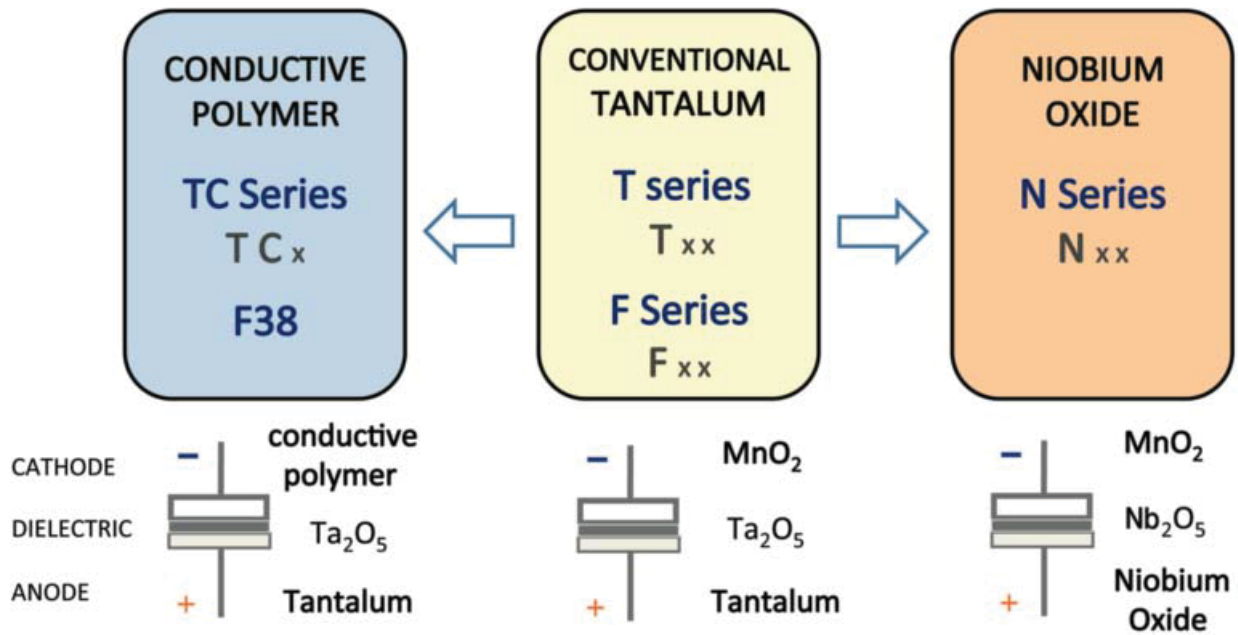

### Five Capacitor Construction Styles

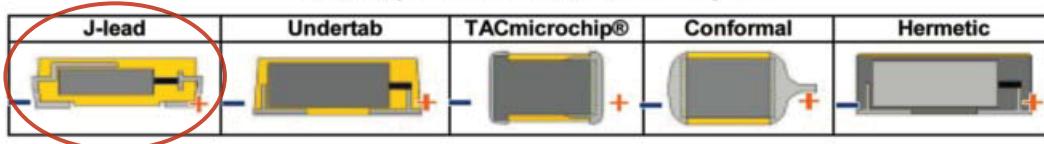

### SERIES LINE UP: CONVENTIONAL SMD MnO<sub>2</sub>

