

ATE

Washable

Subminiature Toggle Switch

RoHS Compliant



UL

Features

1. Twin-contact clip mechanism for high reliability.
2. Process sealed structure
3. Gold-plated contacts.
4. Terminal pin pitch: 2.54 mm.
5. Independent detent mechanism ensures light operational feel.
6. UL recognized (Excluding ATE-J series with plastic cap/rocker)

Specifications

Rating	Max.	50mA 60VAC · DC 0.4VA AC、DC
	Min.	1 μA 20mVAC · DC
Initial contact resistance	50mΩ Max. (1.5mA 200μVAC)	
Dielectric strength	250VAC 1 minute	
Insulation resistance	500MΩ min. (250VDC)	
Electrical life	10,000 cycles at 0.4VA rating. 50,000 cycles at 0.4VA rating. (D.E.N.P type) 30,000 cycles at 0.4VA rating. (F.G.H.R.S.T type)	
Mechanical life	D.E.N.P type 50,000 cycles F.G.H.R.S.T type 30,000 cycles	
Operating temperature range	-20°C ~ +85°C	
Storage temperature range	-40°C ~ +85°C	

Part Numbering

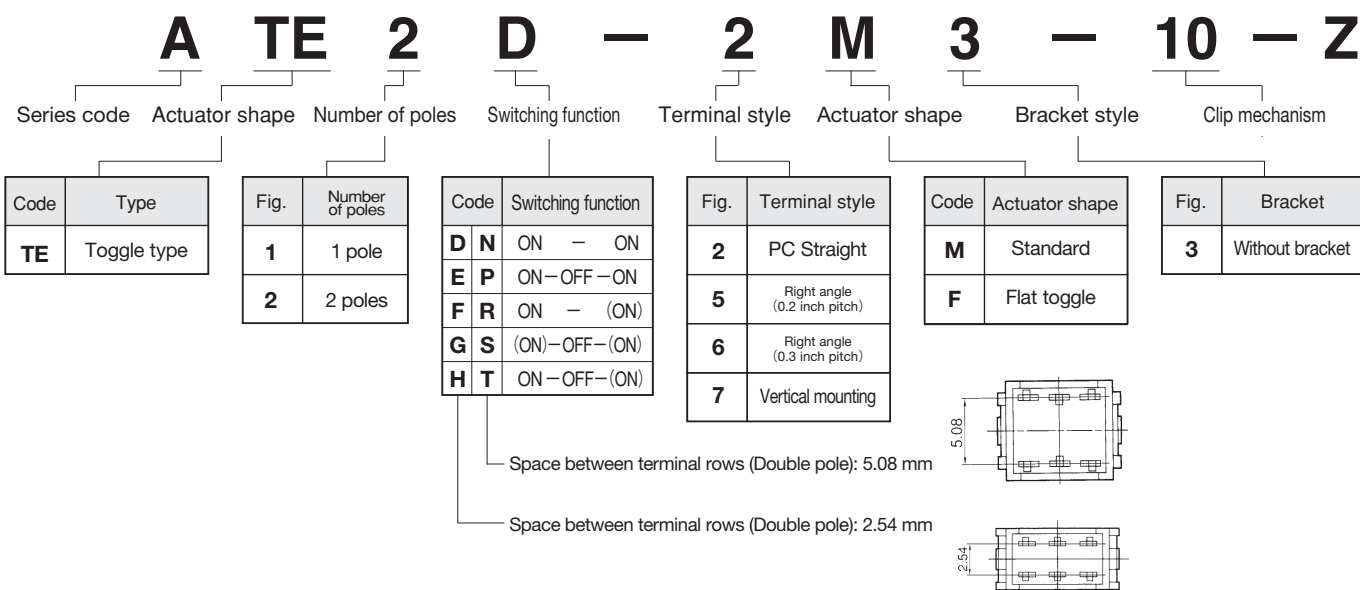

■ Right Angle Terminals

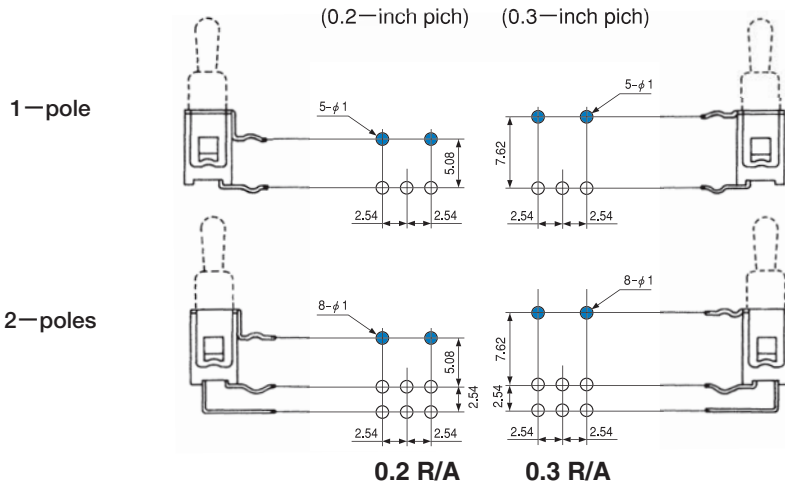

● The space between the terminal rows are available in two dimensions: 0.2 inches (5.08 mm) and 0.3 inches (7.62 mm).

[Example] 0.2-inch pitch: **ATE1D-5M3-10-Z**
0.3-inch pitch: **ATE1D-6M3-10-Z**

■ Optional Accessories

Refer to P.371 for PC Hole Layouts.

Part name	Bracket		
Poles	Single pole	Double poles	
Box size	5 mm	7.5 mm	5 mm
Type	ATE-2M · 2F		
Dimensions			
Part number	140000640314	140000640315	140000640318

Type	ATE-2M·5M·6M·7M
Part name	Color Cap
Dimensions	Gloss finish Vinyl chloride
White	140000470174
Red	140000470175
Black	140000470173
Gray	140000470179
Green	140000470177
Blue	140000470178
Orange	140000470181
Yellow	140000470176
Brown	140000470180

SPDT

PC Straight

Standard Toggle

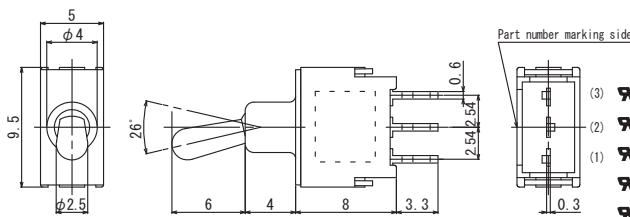
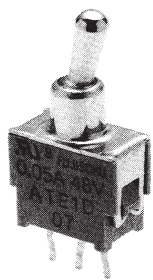

Terminal numbers are not shown on the switch.

Switching function	Viewed from part No. marking side		
Part No.			
ATE1D-2M3-10-Z	ON	—	ON
ATE1E-2M3-10-Z	ON	OFF	ON
ATE1F-2M3-10-Z	ON	—	(ON)
ATE1G-2M3-10-Z	(ON)	OFF	(ON)
☆ATE1H-2M3-10-Z	ON	OFF	(ON)
Connecting terminals	2-3	—	2-1

DPDT

PC Straight

2.54mm/Distance between two terminal rows : 2.54mm

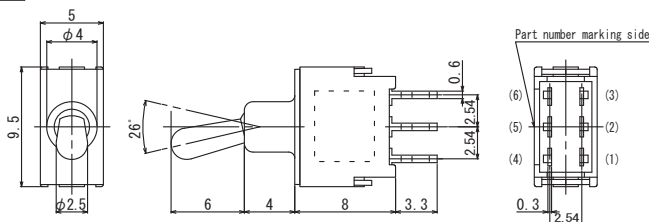
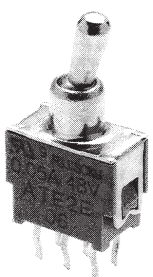

Terminal numbers are not shown on the switch.

Switching function	Viewed from part No. marking side		
Part No.			
ATE2D-2M3-10-Z	ON	—	ON
☆ATE2E-2M3-10-Z	ON	OFF	ON
☆ATE2F-2M3-10-Z	ON	—	(ON)
☆ATE2G-2M3-10-Z	(ON)	OFF	(ON)
☆ATE2H-2M3-10-Z	ON	OFF	(ON)
Connecting terminals	2-3 5-6	—	2-1 5-4

★ : Made to order products.

☆ : Semi-standard products.

(ON) : Momentary.

: Optional Accessories.

ATE

DPDT

(Space between terminal rows : 5.08 mm)

PC Straight

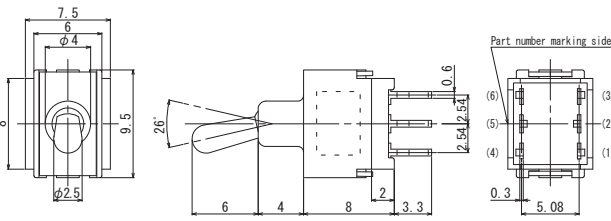

Terminal numbers are not shown on the switch.

Part No.	Viewed from part No. marking side		
☆ ATE2N-2M3-10-Z	ON	—	ON
★ ATE2P-2M3-10-Z	ON	OFF	ON
★ ATE2R-2M3-10-Z	ON	—	(ON)
★ ATE2S-2M3-10-Z	(ON)	OFF	(ON)
★ ATE2T-2M3-10-Z	ON	OFF	(ON)
Connecting terminals	2-3 5-6	—	2-1 5-4

SPDT

(Mounting height : 3.1mm)

Right angle (0.2 inch pitch)

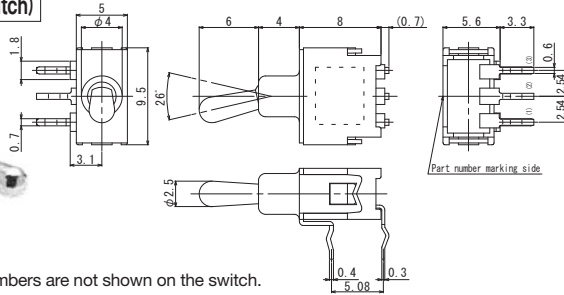
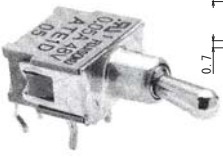

Terminal numbers are not shown on the switch.

Part No.	Viewed from part No. marking side		
ATE1D-5M3-10-Z	ON	—	ON
☆ ATE1E-5M3-10-Z	ON	OFF	ON
★ ATE1F-5M3-10-Z	ON	—	(ON)
☆ ATE1G-5M3-10-Z	(ON)	OFF	(ON)
★ ATE1H-5M3-10-Z	ON	OFF	(ON)
Connecting terminals	2-3	—	2-1

DPDT

(Mounting height : 3.1mm)

Right angle (0.2 inch pitch)

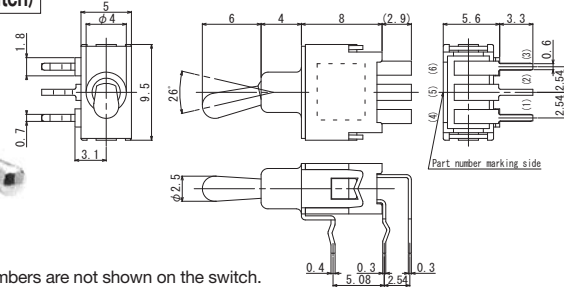
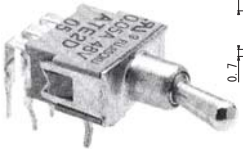

Terminal numbers are not shown on the switch.

Part No.	Viewed from part No. marking side		
☆ ATE2D-5M3-10-Z	ON	—	ON
★ ATE2E-5M3-10-Z	ON	OFF	ON
★ ATE2F-5M3-10-Z	ON	—	(ON)
☆ ATE2G-5M3-10-Z	(ON)	OFF	(ON)
▲ ATE2H-5M3-10-Z	ON	OFF	(ON)
Connecting terminals	2-3 5-6	—	2-1 5-4

DPDT

(Mounting height : 5.15mm)

Right angle (0.2 inch pitch)

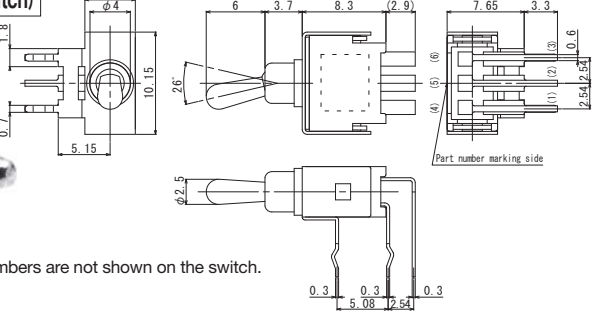
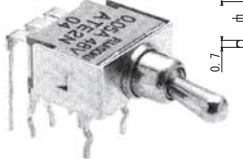

Terminal numbers are not shown on the switch.

Part No.	Viewed from part No. marking side		
☆ ATE2N-5M3-10-Z	ON	—	ON
★ ATE2P-5M3-10-Z	ON	OFF	ON
▲ ATE2R-5M3-10-Z	ON	—	(ON)
★ ATE2S-5M3-10-Z	(ON)	OFF	(ON)
▲ ATE2T-5M3-10-Z	ON	OFF	(ON)
Connecting terminals	2-3 5-6	—	2-1 5-4

SPDT

(Mounting height : 3.1mm)

Right angle (0.3 inch pitch)

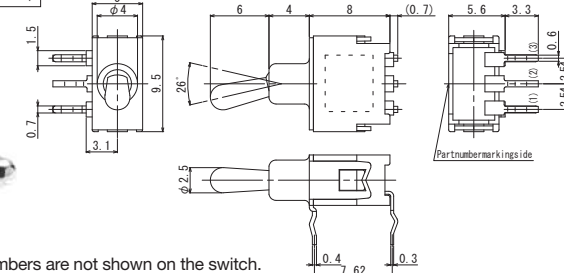

Terminal numbers are not shown on the switch.

Part No.	Viewed from part No. marking side		
ATE1D-6M3-10-Z	ON	—	ON
ATE1E-6M3-10-Z	ON	OFF	ON
ATE1F-6M3-10-Z	ON	—	(ON)
☆ ATE1G-6M3-10-Z	(ON)	OFF	(ON)
☆ ATE1H-6M3-10-Z	ON	OFF	(ON)
Connecting terminals	2-3	—	2-1

(ON) : Momentary.

▲ : Inquiry products.

☆ : Semi-standard products.

★ : Made to order products.

ATE

DPDT

(Mounting height : 3.1mm)

Right angle (0.3 inch pitch)

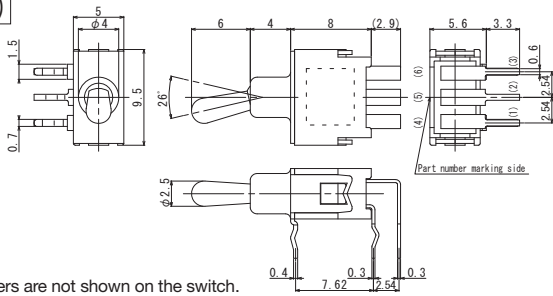
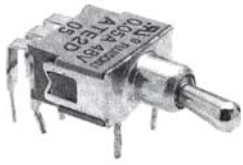

Terminal numbers are not shown on the switch.

Part No.	Switching function		
	Viewed from part No. marking side		
ATE2D-6M3-10-Z	ON	—	ON
★ATE2E-6M3-10-Z	ON	OFF	ON
★ATE2F-6M3-10-Z	ON	—	(ON)
★ATE2G-6M3-10-Z	(ON)	OFF	(ON)
▲ATE2H-6M3-10-Z	ON	OFF	(ON)
Connecting terminals	2-3 5-6	—	2-1 5-4

DPDT

(Mounting height : 5.15mm)

Right angle (0.3 inch pitch)

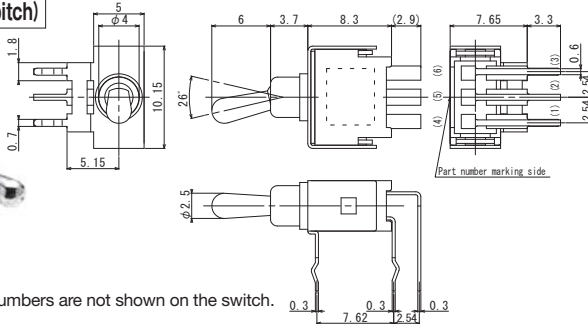
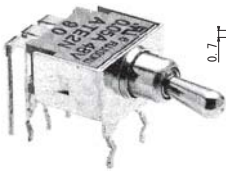

Terminal numbers are not shown on the switch.

Part No.	Switching function		
	Viewed from part No. marking side		
ATE2N-6M3-10-Z	ON	—	ON
☆ATE2P-6M3-10-Z	ON	OFF	ON
★ATE2R-6M3-10-Z	ON	—	(ON)
★ATE2S-6M3-10-Z	(ON)	OFF	(ON)
★ATE2T-6M3-10-Z	ON	OFF	(ON)
Connecting terminals	2-3 5-6	—	2-1 5-4

SPDT

Vertical mounting

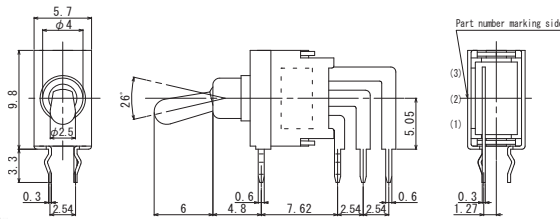
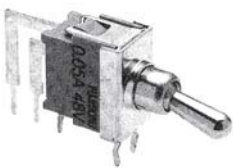

Terminal numbers are not shown on the switch.

Part No.	Switching function		
	Viewed from part No. marking side		
☆ATE1D-7M3-10-Z	ON	—	ON
☆ATE1E-7M3-10-Z	ON	OFF	ON
★ATE1F-7M3-10-Z	ON	—	(ON)
★ATE1G-7M3-10-Z	(ON)	OFF	(ON)
▲ATE1H-7M3-10-Z	ON	OFF	(ON)
Connecting terminals	2-3	—	2-1

DPDT

Vertical mounting

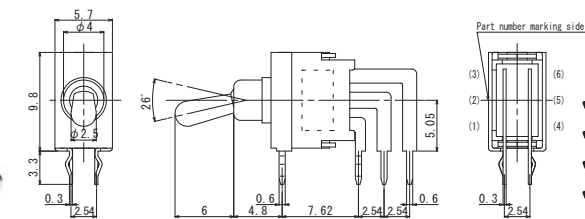
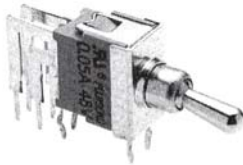

Terminal numbers are not shown on the switch.

Part No.	Switching function		
	Viewed from part No. marking side		
ATE2D-7M3-10-Z	ON	—	ON
★ATE2E-7M3-10-Z	ON	OFF	ON
★ATE2F-7M3-10-Z	ON	—	(ON)
▲ATE2G-7M3-10-Z	(ON)	OFF	(ON)
▲ATE2H-7M3-10-Z	ON	OFF	(ON)
Connecting terminals	2-3 5-6	—	2-1 5-4

SPDT

PC Straight

Flat Toggle

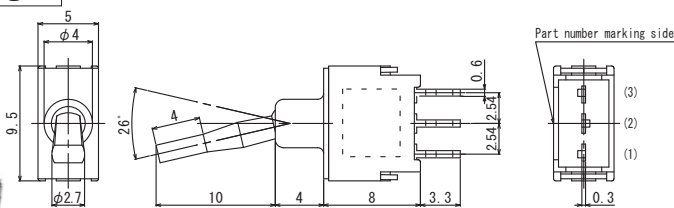

Terminal numbers are not shown on the switch.

Part No.	Switching function		
	Viewed from part No. marking side		
ATE1D-2F3-10-Z	ON	—	ON
ATE1E-2F3-10-Z	ON	OFF	ON
☆ATE1F-2F3-10-Z	ON	—	(ON)
★ATE1G-2F3-10-Z	(ON)	OFF	(ON)
★ATE1H-2F3-10-Z	ON	OFF	(ON)
Connecting terminals	2-3	—	2-1

★ : Made to order products. ☆ : Semi-standard products. ▲ : Inquiry products. (ON) : Momentary.

ATE

DPDT

(Space between terminal rows (Double pole): 2.54 mm)

PC Straight

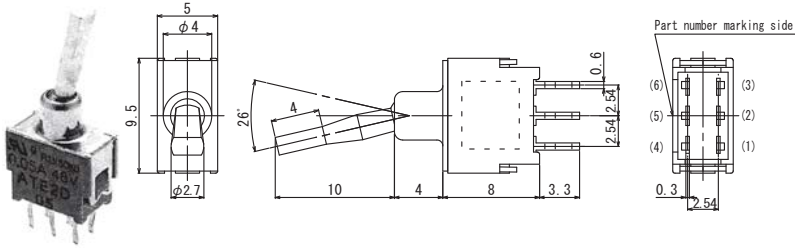

Terminal numbers are not shown on the switch.

Part No.	Viewed from part No. marking side		
☆ ATE2D-2F3-10-Z	ON	—	ON
★ ATE2E-2F3-10-Z	ON	OFF	ON
★ ATE2F-2F3-10-Z	ON	—	(ON)
☆ ATE2G-2F3-10-Z	(ON)	OFF	(ON)
★ ATE2H-2F3-10-Z	ON	OFF	(ON)
Connecting terminals	2-3 5-6	—	2-1 5-4

DPDT

(Space between terminal rows (Double pole): 5.08 mm)

PC Straight

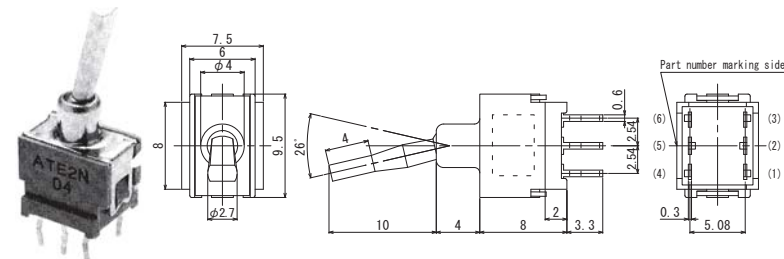

Terminal numbers are not shown on the switch.

Part No.	Viewed from part No. marking side		
☆ ATE2N-2F3-10-Z	ON	—	ON
★ ATE2P-2F3-10-Z	ON	OFF	ON
★ ATE2R-2F3-10-Z	ON	—	(ON)
▲ ATE2S-2F3-10-Z	(ON)	OFF	(ON)
★ ATE2T-2F3-10-Z	ON	OFF	(ON)
Connecting terminals	2-3 5-6	—	2-1 5-4

SPDT

(Mounting height : 3.1mm)

Right angle (0.2 inch pitch)

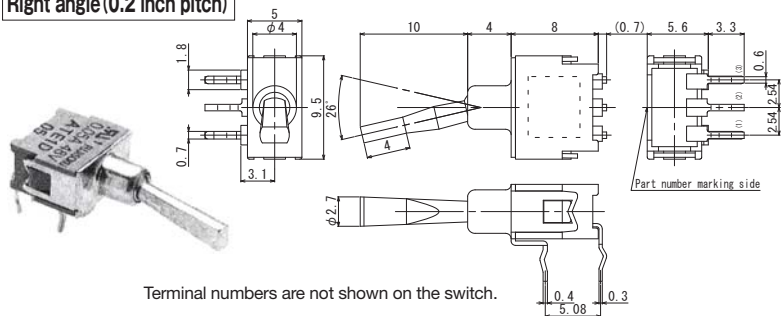

Terminal numbers are not shown on the switch.

Part No.	Viewed from part No. marking side		
☆ ATE1D-5F3-10-Z	ON	—	ON
★ ATE1E-5F3-10-Z	ON	OFF	ON
★ ATE1F-5F3-10-Z	ON	—	(ON)
★ ATE1G-5F3-10-Z	(ON)	OFF	(ON)
★ ATE1H-5F3-10-Z	ON	OFF	(ON)
Connecting terminals	2-3	—	2-1

DPDT

(Mounting height : 3.1mm)

Right angle (0.2 inch pitch)

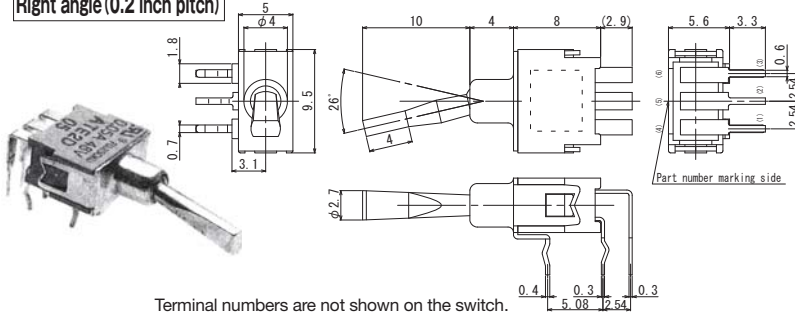

Terminal numbers are not shown on the switch.

Part No.	Viewed from part No. marking side		
★ ATE2D-5F3-10-Z	ON	—	ON
▲ ATE2E-5F3-10-Z	ON	OFF	ON
▲ ATE2F-5F3-10-Z	ON	—	(ON)
★ ATE2G-5F3-10-Z	(ON)	OFF	(ON)
▲ ATE2H-5F3-10-Z	ON	OFF	(ON)
Connecting terminals	2-3 5-6	—	2-1 5-4

DPDT

(Mounting height : 5.15mm)

Right angle (0.2 inch pitch)

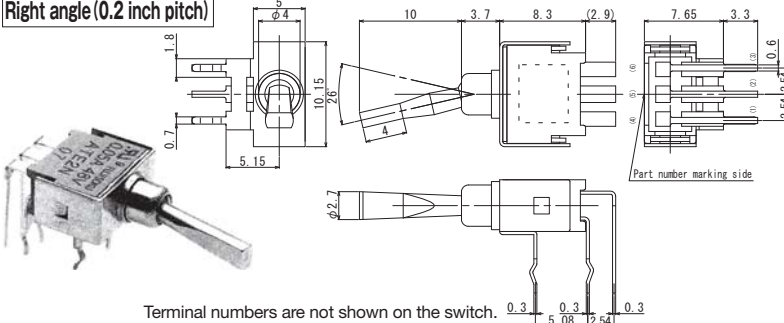

Terminal numbers are not shown on the switch.

Part No.	Viewed from part No. marking side		
★ ATE2N-5F3-10-Z	ON	—	ON
▲ ATE2P-5F3-10-Z	ON	OFF	ON
▲ ATE2R-5F3-10-Z	ON	—	(ON)
▲ ATE2S-5F3-10-Z	(ON)	OFF	(ON)
▲ ATE2T-5F3-10-Z	ON	OFF	(ON)
Connecting terminals	2-3 5-6	—	2-1 5-4

(ON) : Momentary.

▲ : Inquiry products.

☆ : Semi-standard products.

★ : Made to order products.

ATE

SPDT

(Mounting height : 3.1mm)

Right angle (0.3 inch pitch)

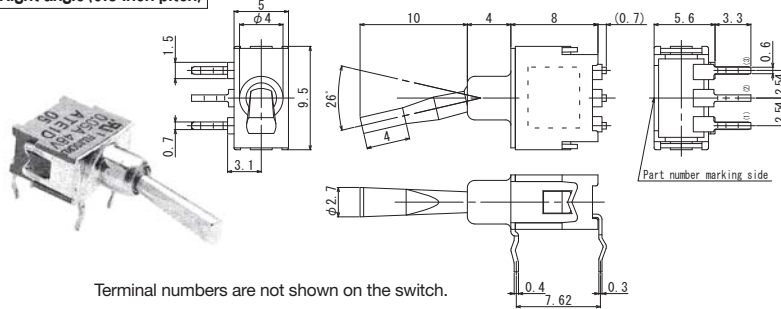

Terminal numbers are not shown on the switch.

Part No.	Viewed from part No. making side		
★ATE1D-6F3-10-Z	ON	—	ON
★ATE1E-6F3-10-Z	ON	OFF	ON
★ATE1F-6F3-10-Z	ON	—	(ON)
☆ATE1G-6F3-10-Z	(ON)	OFF	(ON)
★ATE1H-6F3-10-Z	ON	OFF	(ON)
Connecting terminals	2-3	—	2-1

DPDT

(Mounting height : 3.1mm)

Right angle (0.3 inch pitch)

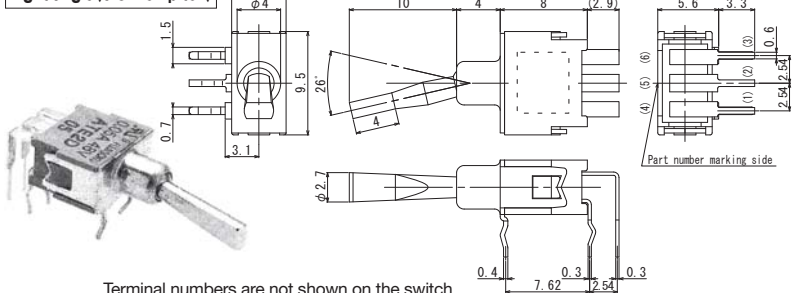

Terminal numbers are not shown on the switch.

Part No.	Viewed from part No. marking side		
☆ATE2D-6F3-10-Z	ON	—	ON
★ATE2E-6F3-10-Z	ON	OFF	ON
▲ATE2F-6F3-10-Z	ON	—	(ON)
▲ATE2G-6F3-10-Z	(ON)	OFF	(ON)
▲ATE2H-6F3-10-Z	ON	OFF	(ON)
Connecting terminals	2-3 5-6	—	2-1 5-4

DPDT

(Mounting height : 5.15mm)

Right angle (0.3 inch pitch)

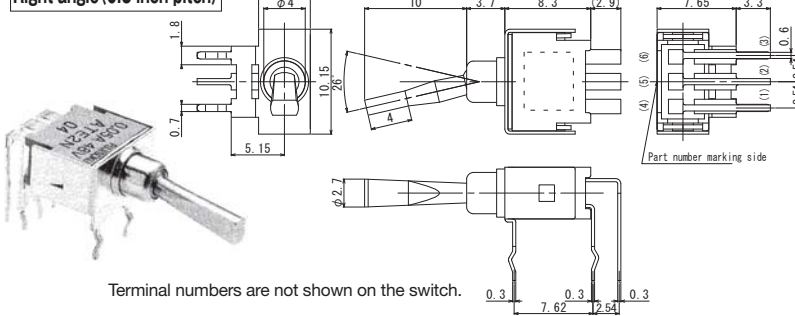

Terminal numbers are not shown on the switch.

Part No.	Viewed from part No. marking side		
★ATE2N-6F3-10-Z	ON	—	ON
▲ATE2P-6F3-10-Z	ON	OFF	ON
▲ATE2R-6F3-10-Z	ON	—	(ON)
▲ATE2S-6F3-10-Z	(ON)	OFF	(ON)
▲ATE2T-6F3-10-Z	ON	OFF	(ON)
Connecting terminals	2-3 5-6	—	2-1 5-4

SPDT

Vertical mounting

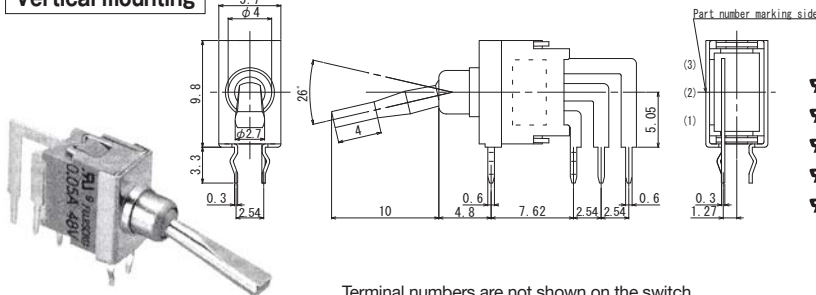

Terminal numbers are not shown on the switch.

Part No.	Viewed from part No. marking side		
★ATE1D-7F3-10-Z	ON	—	ON
▲ATE1E-7F3-10-Z	ON	OFF	ON
★ATE1F-7F3-10-Z	ON	—	(ON)
▲ATE1G-7F3-10-Z	(ON)	OFF	(ON)
★ATE1H-7F3-10-Z	ON	OFF	(ON)
Connecting terminals	2-3	—	2-1

DPDT

Vertical mounting

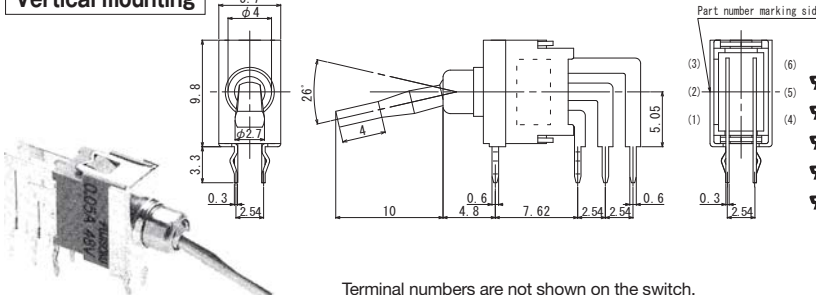

Terminal numbers are not shown on the switch.

Part No.	Viewed from part No. marking side		
★ATE2D-7F3-10-Z	ON	—	ON
★ATE2E-7F3-10-Z	ON	OFF	ON
★ATE2F-7F3-10-Z	ON	—	(ON)
▲ATE2G-7F3-10-Z	(ON)	OFF	(ON)
▲ATE2H-7F3-10-Z	ON	OFF	(ON)
Connecting terminals	2-3 5-6	—	2-1 5-4

ATE-J (Plastic type)

Part Numbering (Plastic cap/Rocker type)

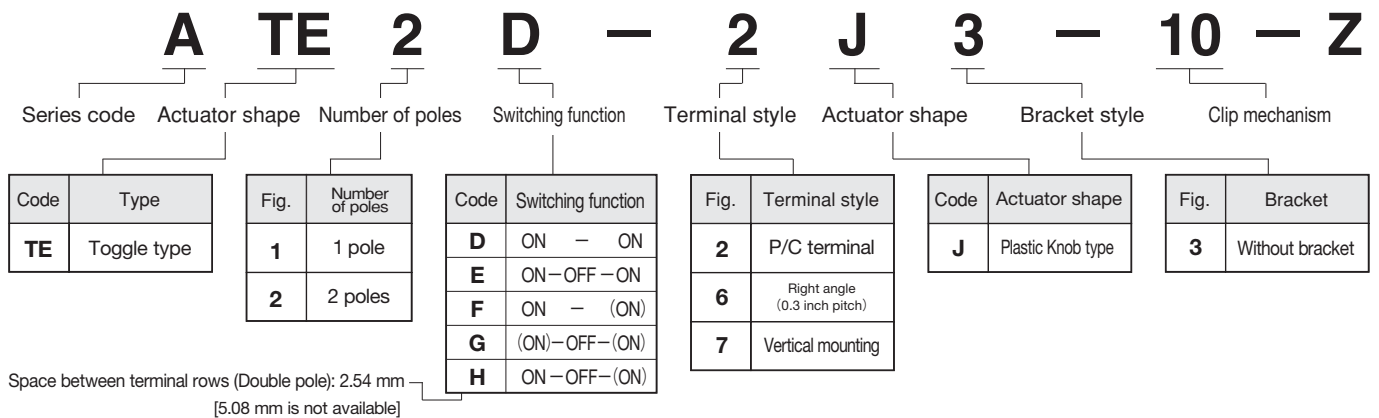

SPDT

PC Straight

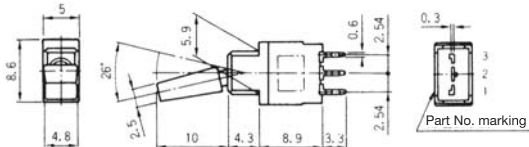

(Mount with CAP)

Switching function	Viewed from part No. marking side		
Part No.			
☆ATE1D-2J3-10-Z	ON	—	ON
★ATE1E-2J3-10-Z	ON	OFF	ON
▲ATE1F-2J3-10-Z	ON	—	(ON)
▲ATE1G-2J3-10-Z	(ON)	OFF	(ON)
★ATE1H-2J3-10-Z	ON	OFF	(ON)
Connecting terminals	2-3	—	2-1

DPDT

PC Straight

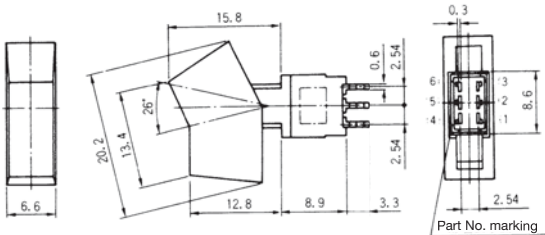

(Mount with Rocker)

Switching function	Viewed from part No. marking side		
Part No.			
★ATE2D-2J3-10-Z	ON	—	ON
▲ATE2E-2J3-10-Z	ON	OFF	ON
▲ATE2F-2J3-10-Z	ON	—	(ON)
▲ATE2G-2J3-10-Z	(ON)	OFF	(ON)
▲ATE2H-2J3-10-Z	ON	OFF	(ON)
Connecting terminals	2-3 5-6	—	2-1 5-4

SPDT

Right angle (0.3 inch pitch)

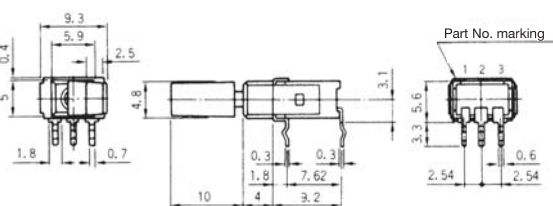
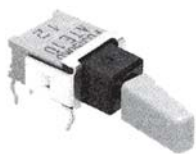

(Mount with CAP)

Switching function	Viewed from part No. marking side		
Part No.			
★ATE1D-6J3-10-Z	ON	—	ON
▲ATE1E-6J3-10-Z	ON	OFF	ON
▲ATE1F-6J3-10-Z	ON	—	(ON)
▲ATE1G-6J3-10-Z	(ON)	OFF	(ON)
▲ATE1H-6J3-10-Z	ON	OFF	(ON)
Connecting terminals	2-3	—	2-1

DPDT

Right angle (0.3 inch pitch)

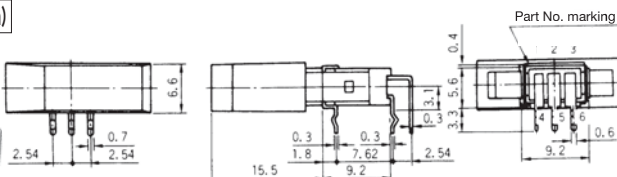
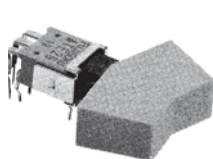

(Mount with Rocker)

Switching function	Viewed from part No. marking side		
Part No.			
▲ATE2D-6J3-10-Z	ON	—	ON
▲ATE2E-6J3-10-Z	ON	OFF	ON
▲ATE2F-6J3-10-Z	ON	—	(ON)
▲ATE2G-6J3-10-Z	(ON)	OFF	(ON)
▲ATE2H-6J3-10-Z	ON	OFF	(ON)
Connecting terminals	2-3 5-6	—	2-1 5-4

Notes:

- Install the cap/rocker accessory after soldering and cleaning.
- Specify the shape and coloring when ordering.
- Space between terminal rows: 5.08 mm is not available.

● Color cap and Rocker accessories are sold separately.

Terminal numbers are not shown on the switch.

(ON) : Momentary.

★ : Made to order products.

☆ : Semi-standard products.

▲ : Inquiry products.

ATE-J

SPDT

Vertical mounting



(Mount with CAP)

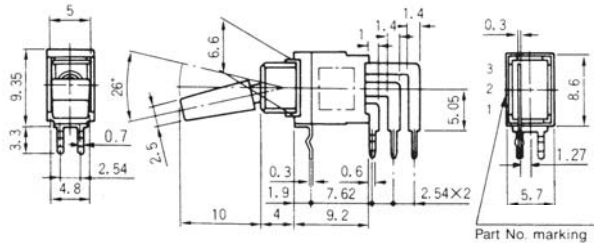

Terminal numbers are not shown on the switch.

Switching function	Viewed from part No. marking side		
Part No.			
★ATE1D-7J3-10-Z	ON	—	ON
▲ATE1E-7J3-10-Z	ON	OFF	ON
▲ATE1F-7J3-10-Z	ON	—	(ON)
▲ATE1G-7J3-10-Z	(ON)	OFF	(ON)
▲ATE1H-7J3-10-Z	ON	OFF	(ON)
Connecting terminals	2-3	—	2-1

DPDT

Vertical mounting



(Mount with Rocker)

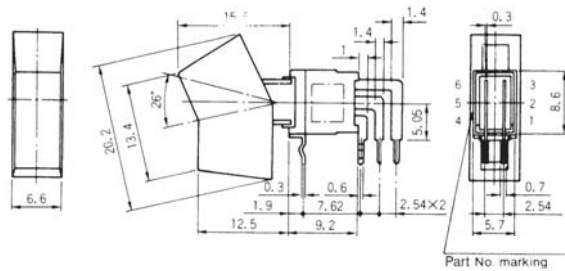

Terminal numbers are not shown on the switch.

Switching function	Viewed from part No. marking side		
Part No.			
▲ATE2D-7J3-10-Z	ON	—	ON
▲ATE2E-7J3-10-Z	ON	OFF	ON
▲ATE2F-7J3-10-Z	ON	—	(ON)
▲ATE2G-7J3-10-Z	(ON)	OFF	(ON)
▲ATE2H-7J3-10-Z	ON	OFF	(ON)
Connecting terminals	2-3 5-6	—	2-1 5-4

Optional Accessories

(Sold separately)

Type	ATE-2J · 6J · 7J	ATE-2J · 6J · 7J
Part name	Color Cap	Rocker
Dimensions		
White	14000050884	140000481541
Red	14000050886	140000481543
Black	14000050885	140000481542
Gray	14000050890	140000481547
Blue	14000050889	140000481546
Green	14000050888	140000481545
Orange	14000050892	140000481549
Yellow	14000050887	140000481544
Brown	14000050891	140000481548

●PC hole layout is different depending on the type of Bracket.

Type	ATE-2J
Part name	Bracket
Dimensions	
Part number	140000640296

Color Cap and Rocker

Installation Procedure for ATE-J type

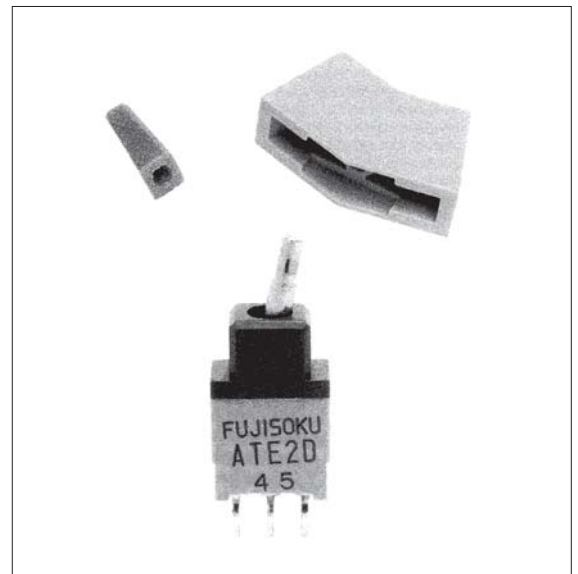

PC Hole Layouts

PC terminal

(Top view)

Series code	ATE-2M·2F·2J	ATE-2M·2F			ATE-2J
Installation	Whithout bracket	When optional bracket is used			
		140000640314	140000640315	140000640318	140000640296
1-pole					
2-poles 2.54mm /To terminal rows					
2-poles 5.08mm /To terminal rows					

Right Angle terminal · Vertical Mount terminal

(Top view)

Series code	ATE-5M · 5F	ATE-6M · 6F · 6J	ATE-7M · 7F · 7J
Terminal	0.2-inch pitch	0.3-inch pitch	Vertical mount
1-pole			
2-poles			

Bracket Mounted Dimensions.

Type	ATE-2M	ATE-2F
	Standard	Flat
Dimensions		

■Soldering Specifications

(1)Manual Soldering

Device : Soldering iron
380°C, Max.; 3 seconds, Max.

(2)Auto Soldering

Device : Jet wave type or dip type
275°C, Max.; 6 seconds, Max.

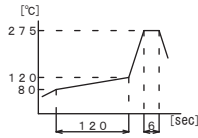

●Pre-heating should be done at temperatures ranging from 80°C to 120°C and within 120 seconds

(3)Install the cap/rocker accessory after soldering and cleaning.

■Flux Cleaning

(1)Solvent : Fluorine or Alcohol type.

(2)Cleaning after soldering should be done after the terminal temperature falls to 90°C or below, or after leaving the switch for five minutes or longer at room temperature.

■Packaging Specifications

<p>Plastick Pack</p>	<p>PC terminals : 100 pcs/pack</p> <p>Right angle terminals : 50 pcs/pack</p>
<p>Plastick Pack</p>	<p>Vertical mounting terminals 100 pcs/pack</p>

■Mounting of Switch

- Use PC boards with hole diameter of 1mm.
- Do not bend the terminal pins before mounting the switch on the PC board.
- After mounting the switch, do not place the device in such a way that the device weight will be applied on to the actuator of the switch.
- Do not apply load exceeding 12.7 N to the actuator.

