



Is Now Part of



ON Semiconductor®

To learn more about ON Semiconductor, please visit our website at
www.onsemi.com

Please note: As part of the Fairchild Semiconductor integration, some of the Fairchild orderable part numbers will need to change in order to meet ON Semiconductor's system requirements. Since the ON Semiconductor product management systems do not have the ability to manage part nomenclature that utilizes an underscore (_), the underscore (_) in the Fairchild part numbers will be changed to a dash (-). This document may contain device numbers with an underscore (_). Please check the ON Semiconductor website to verify the updated device numbers. The most current and up-to-date ordering information can be found at www.onsemi.com. Please email any questions regarding the system integration to Fairchild_questions@onsemi.com.

ON Semiconductor and the ON Semiconductor logo are trademarks of Semiconductor Components Industries, LLC dba ON Semiconductor or its subsidiaries in the United States and/or other countries. ON Semiconductor owns the rights to a number of patents, trademarks, copyrights, trade secrets, and other intellectual property. A listing of ON Semiconductor's product/patent coverage may be accessed at www.onsemi.com/site/pdf/Patent-Marking.pdf. ON Semiconductor reserves the right to make changes without further notice to any products herein. ON Semiconductor makes no warranty, representation or guarantee regarding the suitability of its products for any particular purpose, nor does ON Semiconductor assume any liability arising out of the application or use of any product or circuit, and specifically disclaims any and all liability, including without limitation special, consequential or incidental damages. Buyer is responsible for its products and applications using ON Semiconductor products, including compliance with all laws, regulations and safety requirements or standards, regardless of any support or applications information provided by ON Semiconductor. "Typical" parameters which may be provided in ON Semiconductor data sheets and/or specifications can and do vary in different applications and actual performance may vary over time. All operating parameters, including "Typicals" must be validated for each customer application by customer's technical experts. ON Semiconductor does not convey any license under its patent rights nor the rights of others. ON Semiconductor products are not designed, intended, or authorized for use as a critical component in life support systems or any FDA Class 3 medical devices or medical devices with a same or similar classification in a foreign jurisdiction or any devices intended for implantation in the human body. Should Buyer purchase or use ON Semiconductor products for any such unintended or unauthorized application, Buyer shall indemnify and hold ON Semiconductor and its officers, employees, subsidiaries, affiliates, and distributors harmless against all claims, costs, damages, and expenses, and reasonable attorney fees arising out of, directly or indirectly, any claim of personal injury or death associated with such unintended or unauthorized use, even if such claim alleges that ON Semiconductor was negligent regarding the design or manufacture of the part. ON Semiconductor is an Equal Opportunity/Affirmative Action Employer. This literature is subject to all applicable copyright laws and is not for resale in any manner.

KA4558

Dual Operational Amplifier

Features

- No frequency compensation required.
- No latch up.
- Large common mode and differential voltage range.
- Parameter tracking over temperature range.
- Gain and phase match between amplifiers.
- Internally frequency compensated.
- Low noise input transistors.

Descriptions

The KA4558 is a monolithic integrated circuit designed for dual operational amplifier.

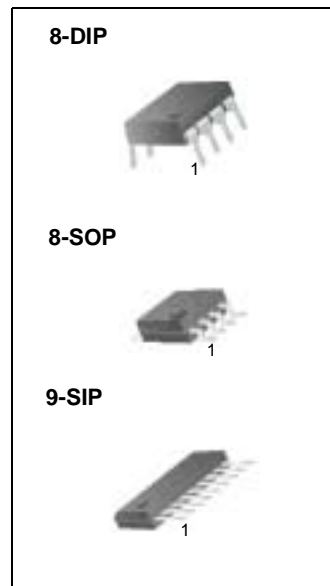

Internal Block Diagram

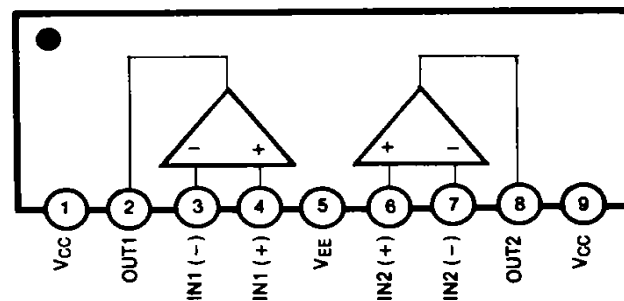
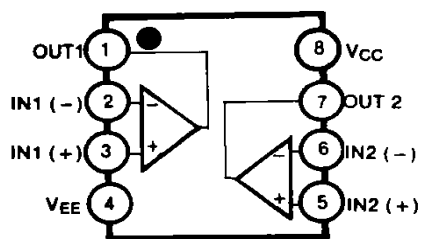

Schematic Diagram

(One Section Only)

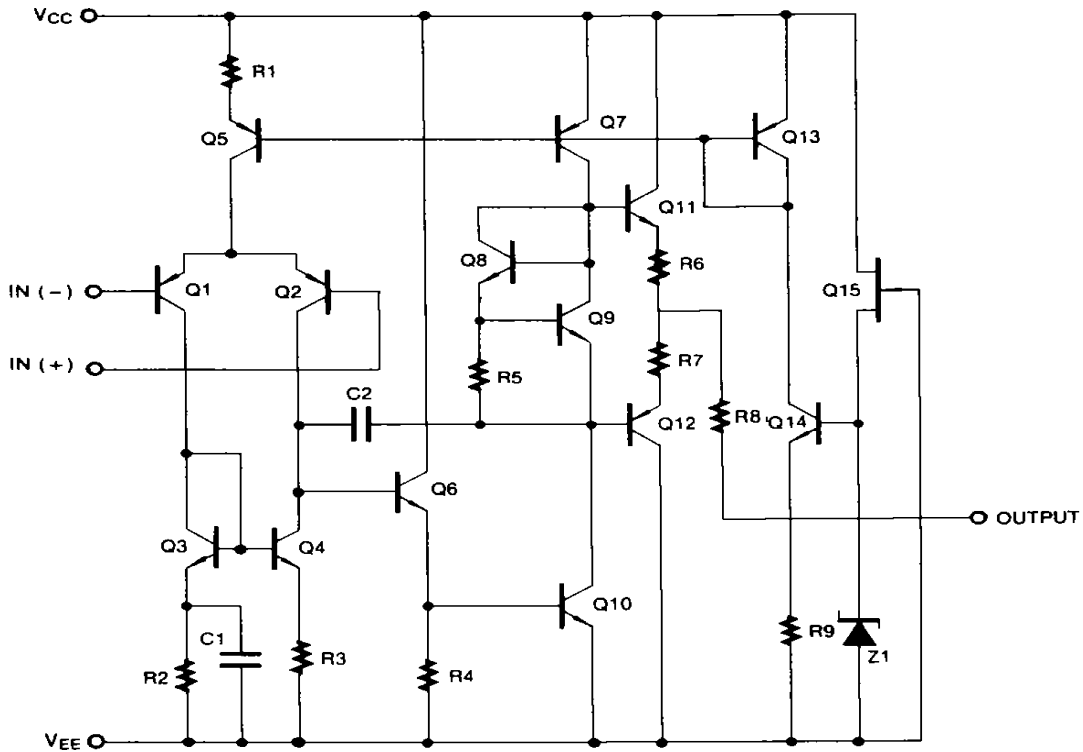

Absolute Maximum Ratings

Parameter	Symbol	Value	Unit
Supply Voltage	VCC	±22	V
Differential Input Voltage	VI(DIFF)	30	V
Input Voltage	VI	±15	V
Power Dissipation	PD	400	mW
Operating Temperature Range KA4558 KA4558I	TOPR	0 ~ 70 -40 ~ 85	°C
Storage Temperature Range	TSTG	-65 ~ 150	°C

Electrical Characteristics

(VCC = 15V, VEE = - 15V ,TA = 25 °C unless otherwise specified)

Parameter	Symbol	Conditions	KA4558/KA4558I			Unit	
			Min	Typ	Max		
Input Offset Voltage	V _{IO}	R _S ≤ 10KΩ Note 1	-	2	6	mV	
			-	-	7.5		
Input Offset Current	I _{IO}		-	5	200	nA	
			T _A = T _A (MAX)	-	-		300
			T _A = T _A (MIN)	-	-		300
Input Bias Current	I _{BIAS}		-	30	500	nA	
			T _A = T _A (MAX)	-	-		800
			T _A = T _A (MIN)	-	-		800
Large Signal Voltage Gain	G _V	V _O (P-P) = ±10V, R _L ≤ 2KΩ Note 1	20	200	-	V/mV	
			-	-	-		
Common Mode Input Voltage Range	V _{I(R)}		±12	±13	-	V	
			-	-	-		
Common Mode Rejection Ratio	CMRR	R _S ≤ 10KΩ Note 1	70	90	-	dB	
			-	-	-		
Supply Voltage Rejection Ratio	PSRR	R _S ≤ 10KΩ Note 1	76	90	-	dB	
			76	90	-		
Output Voltage Swing	V _O (P-P)	R _L ≥ 10KΩ Note1	±12	±14	-	V	
		R _L ≥ 2KΩ	±10	±13	-		
Supply Current (Both Amplifiers)	I _{CC}		-	3.5	5.8	mA	
			T _A = T _A (MAX)	-	-		5.0
			T _A = T _A (MIN)	-	-		6.7
Power Consumption (Both Amplifiers)	P _C		-	70	170	mW	
			T _A = T _A (MAX)	-	-		150
			T _A = T _A (MIN)	-	-		200
Slew Rate (Note2)	SR	V _I = 10V, R _L ≥ 2KΩ C _I ≤ 100pF	1.2	-	-	V/μs	
Rise Time (Note2)	T _R	V _I = 20mV, R _L ≥ 2KΩ C _I ≤ 100pF	-	0.3	-	μs	
Overshoot (Note2)	OS	V _I = 20mV, R _L ≥ 2KΩ C _I ≤ 100pF	-	15	-	%	

Note :

- KA4558 : T_A(MIN) ≤ T_A ≤ T_A(MAX) = 0 ≤ T_A ≤ 70 °C , KA4558I : T_A(MIN) ≤ T_A ≤ T_A(MAX) = -40 ≤ T_A ≤ +85 °C
- Guaranteed by design.

Typical Performance Characteristics

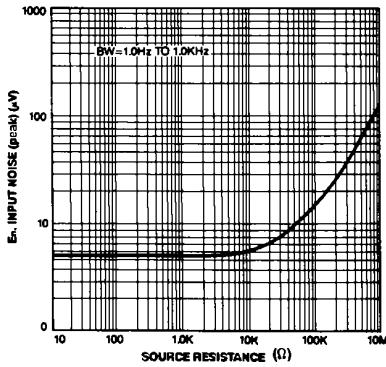

Figure 1. Burst Noise vs Source Resistance

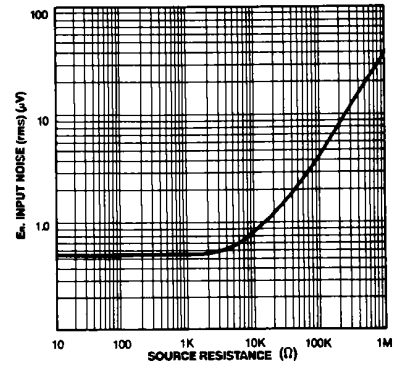

Figure 2. RMS Noise vs Source Resistance

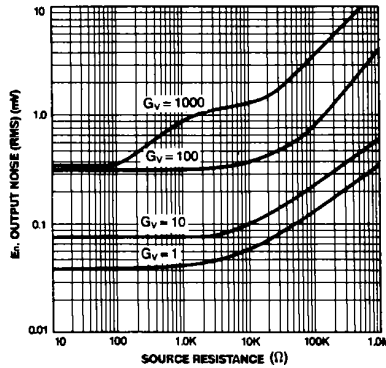

Figure 3. Output Noise vs Source Resistance

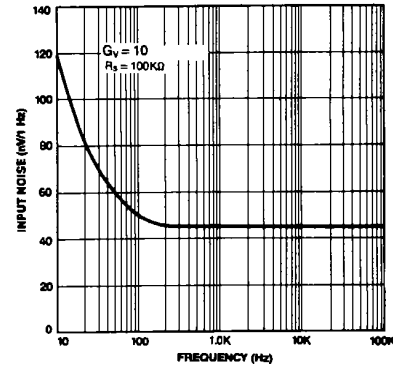

Figure 4. Spectral Noise Density

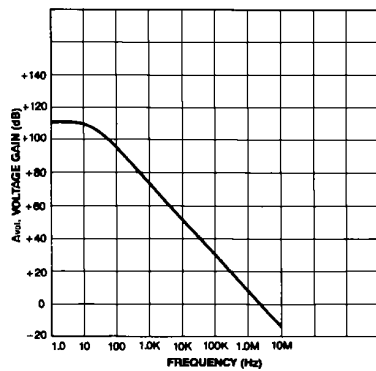

Figure 5. Open Loop Frequency Response

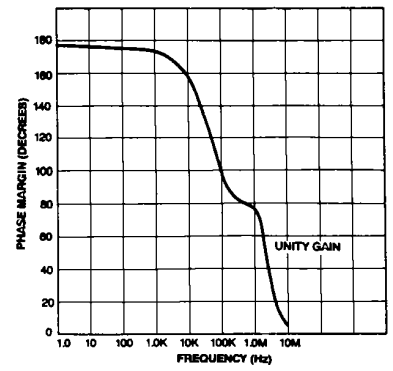

Figure 6. Phase Margin vs Frequency

Typical Performance Characteristics (continued)

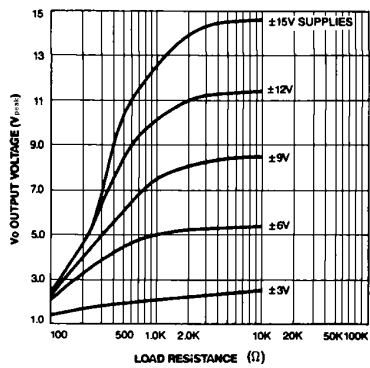

Figure 7. Positive Output Voltage Swing vs Load Resistance

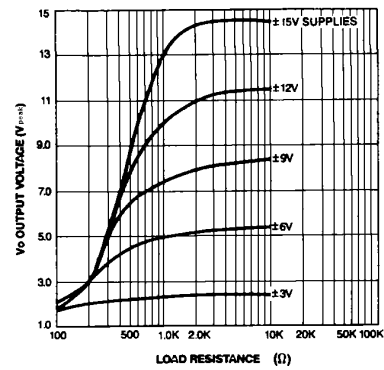

Figure 8. Negative Output Voltage Swing vs Load Resistance

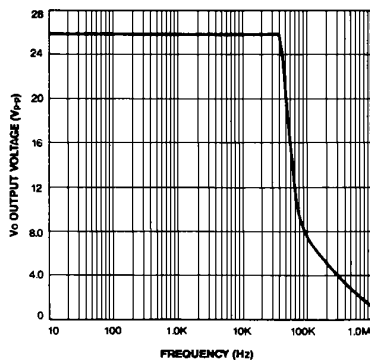
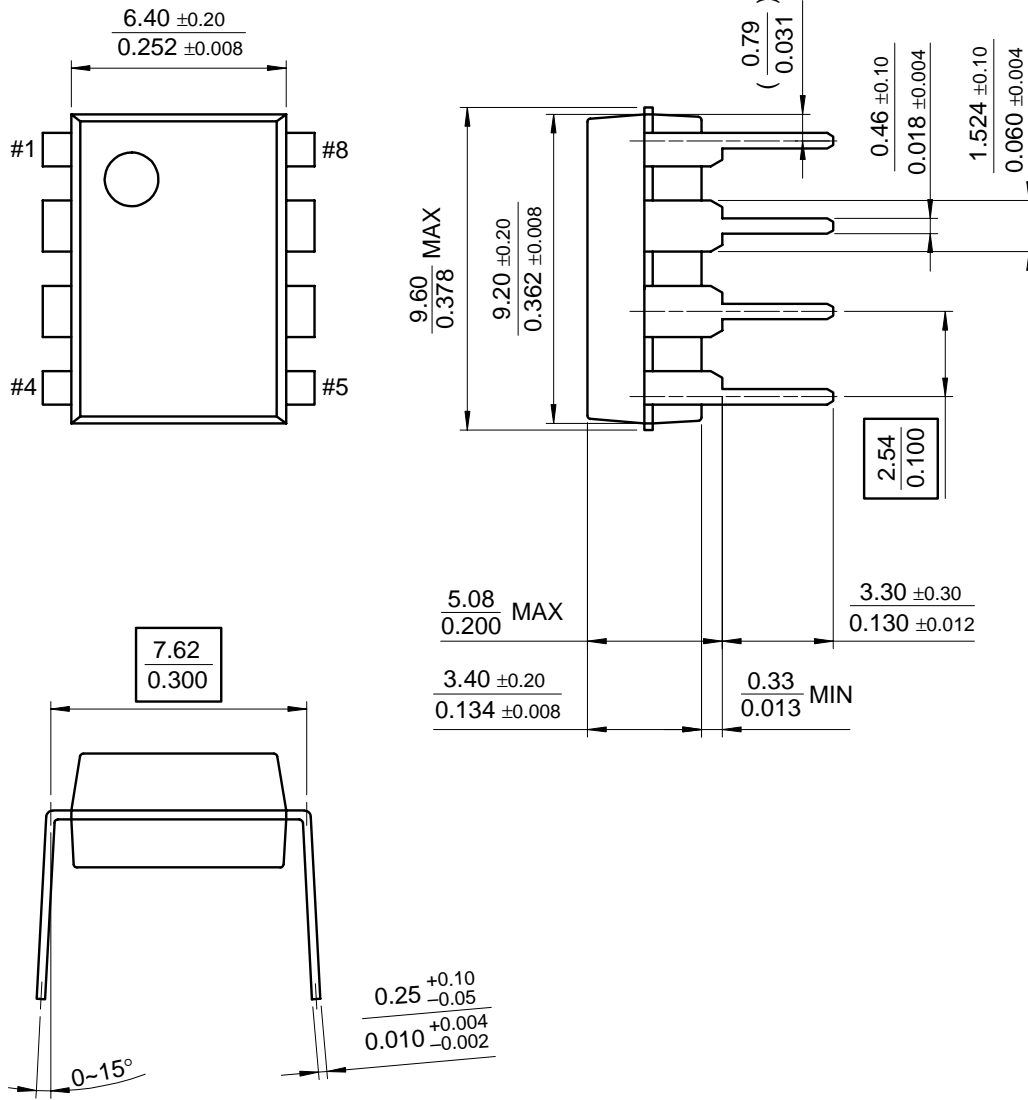

Figure 9. Power Bandwidth (Large Signal Output Swing vs Frequency)

Mechanical Dimensions

Package

8-DIP



Mechanical Dimensions (Continued)

Package

8-SOP

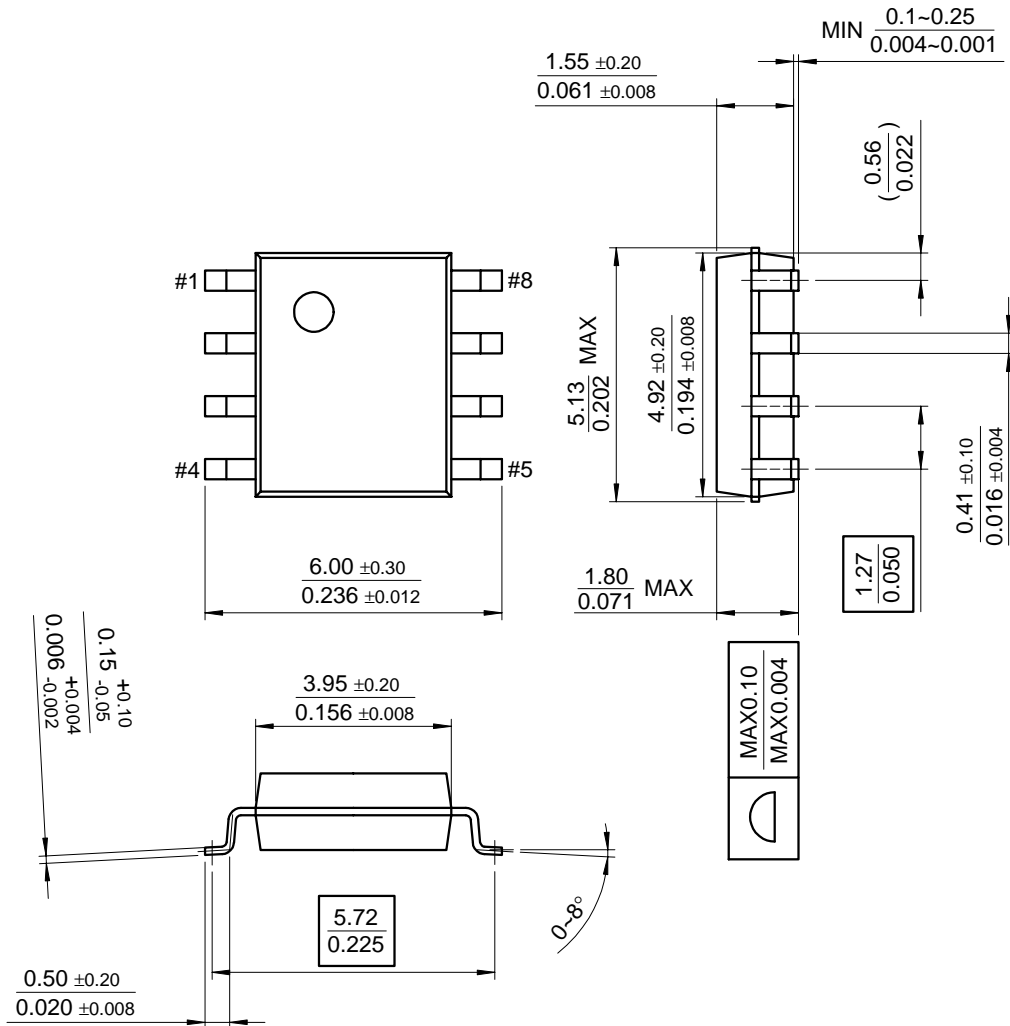

Mechanical Dimensions (Continued)

Package

9-SIP

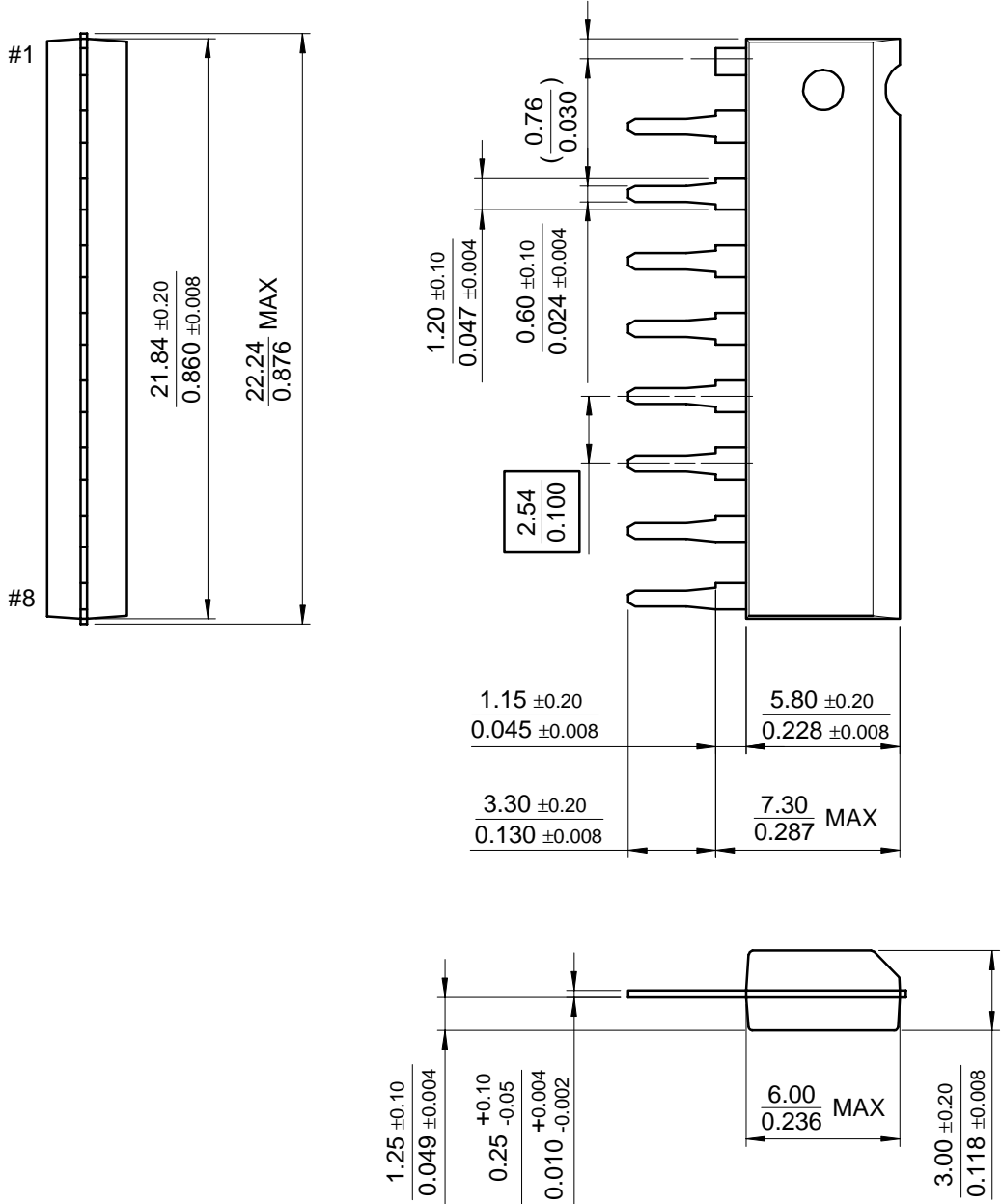

Ordering Information

Product Number	Package	Operating Temperature
KA4558	8-DIP	0 ~ + 70°C
KA4558D	8-SOP	
KA4558S	9-SIP	
KA4558I	8-DIP	-40 ~ + 85°C

DISCLAIMER

FAIRCHILD SEMICONDUCTOR RESERVES THE RIGHT TO MAKE CHANGES WITHOUT FURTHER NOTICE TO ANY PRODUCTS HEREIN TO IMPROVE RELIABILITY, FUNCTION OR DESIGN. FAIRCHILD DOES NOT ASSUME ANY LIABILITY ARISING OUT OF THE APPLICATION OR USE OF ANY PRODUCT OR CIRCUIT DESCRIBED HEREIN; NEITHER DOES IT CONVEY ANY LICENSE UNDER ITS PATENT RIGHTS, NOR THE RIGHTS OF OTHERS.

LIFE SUPPORT POLICY

FAIRCHILD'S PRODUCTS ARE NOT AUTHORIZED FOR USE AS CRITICAL COMPONENTS IN LIFE SUPPORT DEVICES OR SYSTEMS WITHOUT THE EXPRESS WRITTEN APPROVAL OF THE PRESIDENT OF FAIRCHILD SEMICONDUCTOR CORPORATION. As used herein:

1. Life support devices or systems are devices or systems which, (a) are intended for surgical implant into the body, or (b) support or sustain life, and (c) whose failure to perform when properly used in accordance with instructions for use provided in the labeling, can be reasonably expected to result in a significant injury of the user.
2. A critical component in any component of a life support device or system whose failure to perform can be reasonably expected to cause the failure of the life support device or system, or to affect its safety or effectiveness.

ON Semiconductor and  are trademarks of Semiconductor Components Industries, LLC dba ON Semiconductor or its subsidiaries in the United States and/or other countries. ON Semiconductor owns the rights to a number of patents, trademarks, copyrights, trade secrets, and other intellectual property. A listing of ON Semiconductor's product/patent coverage may be accessed at www.onsemi.com/site/pdf/Patent-Marking.pdf. ON Semiconductor reserves the right to make changes without further notice to any products herein. ON Semiconductor makes no warranty, representation or guarantee regarding the suitability of its products for any particular purpose, nor does ON Semiconductor assume any liability arising out of the application or use of any product or circuit, and specifically disclaims any and all liability, including without limitation special, consequential or incidental damages. Buyer is responsible for its products and applications using ON Semiconductor products, including compliance with all laws, regulations and safety requirements or standards, regardless of any support or applications information provided by ON Semiconductor. "Typical" parameters which may be provided in ON Semiconductor data sheets and/or specifications can and do vary in different applications and actual performance may vary over time. All operating parameters, including "Typicals" must be validated for each customer application by customer's technical experts. ON Semiconductor does not convey any license under its patent rights nor the rights of others. ON Semiconductor products are not designed, intended, or authorized for use as a critical component in life support systems or any FDA Class 3 medical devices or medical devices with a same or similar classification in a foreign jurisdiction or any devices intended for implantation in the human body. Should Buyer purchase or use ON Semiconductor products for any such unintended or unauthorized application, Buyer shall indemnify and hold ON Semiconductor and its officers, employees, subsidiaries, affiliates, and distributors harmless against all claims, costs, damages, and expenses, and reasonable attorney fees arising out of, directly or indirectly, any claim of personal injury or death associated with such unintended or unauthorized use, even if such claim alleges that ON Semiconductor was negligent regarding the design or manufacture of the part. ON Semiconductor is an Equal Opportunity/Affirmative Action Employer. This literature is subject to all applicable copyright laws and is not for resale in any manner.

PUBLICATION ORDERING INFORMATION

LITERATURE FULFILLMENT:

Literature Distribution Center for ON Semiconductor
19521 E. 32nd Pkwy, Aurora, Colorado 80011 USA
Phone: 303-675-2175 or 800-344-3860 Toll Free USA/Canada
Fax: 303-675-2176 or 800-344-3867 Toll Free USA/Canada
Email: orderlit@onsemi.com

N. American Technical Support: 800-282-9855 Toll Free
USA/Canada
Europe, Middle East and Africa Technical Support:
Phone: 421 33 790 2910
Japan Customer Focus Center
Phone: 81-3-5817-1050

ON Semiconductor Website: www.onsemi.com
Order Literature: <http://www.onsemi.com/orderlit>
For additional information, please contact your local
Sales Representative