



Is Now Part of



**ON Semiconductor®**

To learn more about ON Semiconductor, please visit our website at  
[www.onsemi.com](http://www.onsemi.com)

Please note: As part of the Fairchild Semiconductor integration, some of the Fairchild orderable part numbers will need to change in order to meet ON Semiconductor's system requirements. Since the ON Semiconductor product management systems do not have the ability to manage part nomenclature that utilizes an underscore (\_), the underscore (\_) in the Fairchild part numbers will be changed to a dash (-). This document may contain device numbers with an underscore (\_). Please check the ON Semiconductor website to verify the updated device numbers. The most current and up-to-date ordering information can be found at [www.onsemi.com](http://www.onsemi.com). Please email any questions regarding the system integration to [Fairchild\\_questions@onsemi.com](mailto:Fairchild_questions@onsemi.com).

ON Semiconductor and the ON Semiconductor logo are trademarks of Semiconductor Components Industries, LLC dba ON Semiconductor or its subsidiaries in the United States and/or other countries. ON Semiconductor owns the rights to a number of patents, trademarks, copyrights, trade secrets, and other intellectual property. A listing of ON Semiconductor's product/patent coverage may be accessed at [www.onsemi.com/site/pdf/Patent-Marking.pdf](http://www.onsemi.com/site/pdf/Patent-Marking.pdf). ON Semiconductor reserves the right to make changes without further notice to any products herein. ON Semiconductor makes no warranty, representation or guarantee regarding the suitability of its products for any particular purpose, nor does ON Semiconductor assume any liability arising out of the application or use of any product or circuit, and specifically disclaims any and all liability, including without limitation special, consequential or incidental damages. Buyer is responsible for its products and applications using ON Semiconductor products, including compliance with all laws, regulations and safety requirements or standards, regardless of any support or applications information provided by ON Semiconductor. "Typical" parameters which may be provided in ON Semiconductor data sheets and/or specifications can and do vary in different applications and actual performance may vary over time. All operating parameters, including "Typicals" must be validated for each customer application by customer's technical experts. ON Semiconductor does not convey any license under its patent rights nor the rights of others. ON Semiconductor products are not designed, intended, or authorized for use as a critical component in life support systems or any FDA Class 3 medical devices or medical devices with a same or similar classification in a foreign jurisdiction or any devices intended for implantation in the human body. Should Buyer purchase or use ON Semiconductor products for any such unintended or unauthorized application, Buyer shall indemnify and hold ON Semiconductor and its officers, employees, subsidiaries, affiliates, and distributors harmless against all claims, costs, damages, and expenses, and reasonable attorney fees arising out of, directly or indirectly, any claim of personal injury or death associated with such unintended or unauthorized use, even if such claim alleges that ON Semiconductor was negligent regarding the design or manufacture of the part. ON Semiconductor is an Equal Opportunity/Affirmative Action Employer. This literature is subject to all applicable copyright laws and is not for resale in any manner.



# FAN4931

## Ultra-Low Cost, Rail-to-Rail I/O, CMOS Amplifier

### Features

- 200  $\mu$ A Supply Current per Amplifier
- 3.7 MHz Bandwidth
- Output Swing to within 10 mV of Either Rail
- Input Voltage Range Exceeds the Rails
- 3 V/ $\mu$ s Slew Rate
- 25 nV/ $\sqrt{\text{Hz}}$  Input Voltage Noise
- FAN4931 Competes with LMV931; Available in SC70-5 Package
- Fully Specified at +2.7 V and +5 V Supplies

### Applications

- Motor Control
- Portable / Battery-Powered Applications
- PCMCIA, USB
- Mobile Communications, Cellular Phones, Pagers
- Notebooks and PDAs
- Sensor Interface
- A/D Buffer
- Active Filters
- Signal Conditioning
- Portable Test Instruments

### Description

FAN4931 is an ultra-low cost voltage feedback amplifier with CMOS inputs that consumes only 200  $\mu$ A of supply current, while providing  $\pm 33$  mA of output short-circuit current. This amplifier is designed to operate from 2.5 V to 5 V supplies. The common-mode voltage range extends beyond the negative and positive rails.

The FAN4931 is designed on a CMOS process and provides 3.7 MHz of bandwidth and 3 V /  $\mu$ s of slew rate at a supply voltage of 5 V. This amplifier operates and is reliable over a wide temperature range  $-40^{\circ}\text{C}$  to  $+125^{\circ}\text{C}$ . The combination of extended temperature operation, low power, rail-to-rail performance, low voltage operation, and tiny package optimizes this amplifier for use in many industrial, general purpose and battery powered applications.

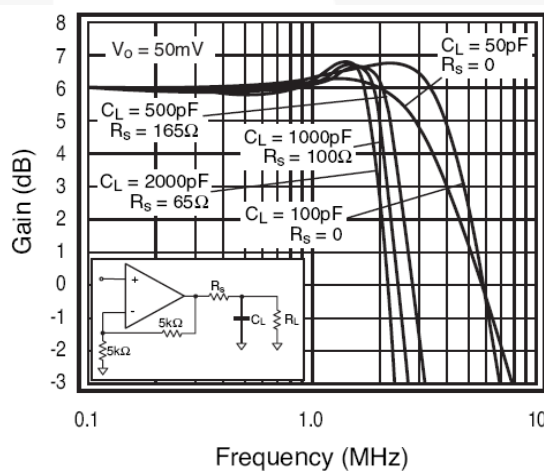

Figure 1. Frequency vs. Gain

### Ordering Information

Part Number	Operating Temperature Range	Package	Packing Method
FAN4931IP5X	$-40$ to $+125^{\circ}\text{C}$	5-Lead SC70 Package	Tape and Reel (3000)

## Typical Application

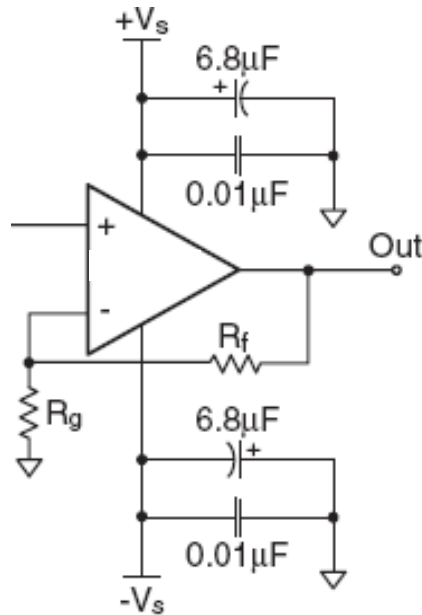

Figure 2. Typical Application

## Pin Configurations

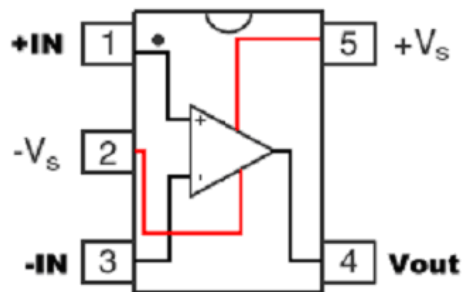

Figure 3. Pin Assignments

## Pin Assignments

Pin #	Name	Description
1	+IN	Positive Input
2	-Vs	Negative Supply
3	-IN	Negative Input
4	V <sub>OUT</sub>	Output
5	+Vs	Positive Supply

## Absolute Maximum Ratings

Stresses exceeding the absolute maximum ratings may damage the device. The device may not function or be operable above the recommended operating conditions and stressing the parts to these levels is not recommended. In addition, extended exposure to stresses above the recommended operating conditions may affect device reliability. The absolute maximum ratings are stress ratings only. Functional operation under any of these conditions is NOT implied. Performance and reliability are guaranteed only if operating conditions are not exceeded.

Symbol	Parameter		Min.	Max.	Unit
$V_{CC}$	Supply Voltage		0	6	V
$V_{IN}$	Input Voltage Range		$-V_S-0.5$	$+V_S+0.5$	V
$T_J$	Junction Temperature			+150	°C
$T_{STG}$	Storage Temperature		-65	+150	°C
$T_L$	Lead Soldering, 10 Seconds			+300	°C
$\theta_{JA}$	Thermal Resistance <sup>(1)</sup>			331	°C/W
ESD	Electrostatic Discharge Capability	Human Body Model, JESD22-A114		5	kV
		Charged Device Model, JESD22-C101		2	

### Note:

1. Package thermal resistance JEDEC standard, multi-layer test boards, still air.

## Recommended Operating Conditions

The Recommended Operating Conditions table defines the conditions for actual device operation. Recommended operating conditions are specified to ensure optimal performance to the datasheet specifications. Fairchild does not recommend exceeding them or designing to Absolute Maximum Ratings.

Symbol	Parameter	Min.	Max.	Unit
$+V_S$	Supply Voltage	2.30	5.25	V
$T_A$	Operating Temperature Range	-40	+125	°C

**Electrical Specifications at +2.7V**

$V_S=+2.7\text{ V}$ ,  $G=2$ ,  $R_L=10\text{ k}\Omega$  to  $V_S/2$ ,  $R_F=5\text{ k}\Omega$ ; unless otherwise noted.

Symbol	Parameter	Conditions	Min.	Typ.	Max.	Units
<b>Frequency Domain Response</b>						
UGBW	-3dB Bandwidth	$G=+1$		4.0		MHz
BW <sub>SS</sub>				2.5		MHz
GBWP	Gain Bandwidth Product			4		MHz
<b>Time Domain Response</b>						
$t_R, t_F$	Rise and Fall Time	$V_O=1.0\text{ V Step}$		300		ns
OS	Overshoot	$V_O=1.0\text{ V Step}$		5		%
SR	Slew Rate	$V_O=3\text{ V Step}, G=-1$		3		V/ $\mu$ s
<b>Distortion and Noise Response</b>						
HD2	2nd Harmonic Distortion	$V_O=1\text{ V}_{PP}, 10\text{ kHz}$		-66		dBc
HD3	3rd Harmonic Distortion	$V_O=1\text{ V}_{PP}, 10\text{ kHz}$		-67		dBc
THD	Total Harmonic Distortion	$V_O=1\text{ V}_{PP}, 10\text{ kHz}$		0.1		%
$e_n$	Input Voltage Noise			26		nV/ $\sqrt{\text{Hz}}$
<b>DC Performance</b>						
$V_{IO}$	Input Offset Voltage <sup>(2)</sup>		-6	0	+6	mV
$dV_{IO}$	Average Drift			2.1		$\mu\text{V}/^\circ\text{C}$
$I_{bn}$	Input Bias Current			5		pA
PSRR	Power Supply Rejection Ratio <sup>(2)</sup>	DC	50	73		dB
$A_{OL}$	Open-Loop Gain	DC		98		dB
$I_S$	Supply Current per Amplifier <sup>(2)</sup>			200	300	$\mu\text{A}$
<b>Input Characteristics</b>						
$R_{IN}$	Input Resistance			10		G $\Omega$
$C_{IN}$	Input Capacitance			1.4		pF
CMIR	Input Common Mode Voltage Range			-0.3 to 2.8		V
CMRR	Common Mode Rejection Ratio <sup>(2)</sup>	DC, $V_{CM}=0\text{V to }2.2\text{ V}$	50	65		dB
<b>Output Characteristics</b>						
$V_O$	Output Voltage Swing <sup>(2)</sup>	$R_L=10\text{ k}\Omega$ to $V_S/2$	0.03	0.01 to 2.69	2.65	V
		$R_L=1\text{ k}\Omega$ to $V_S/2$		0.05 to 2.55		
$I_{SC}$	Short-Circuit Output Current			+34/-12		mA
$V_S$	Power Supply Operating Range			2.5 to 5.5		V

**Note:**

2. 100% tested at  $T_A=25^\circ\text{C}$ .

## Electrical Specifications at +5V

$V_S=+5\text{ V}$ ,  $G=2$ ,  $R_L=10\text{ k}\Omega$  to  $V_S/2$ ,  $R_F=5\text{ k}\Omega$ ; unless otherwise noted.

Symbol	Parameter	Conditions	Min.	Typ.	Max.	Units
<b>Frequency Domain Response</b>						
UGBW	-3dB Bandwidth	$G=+1$		3.7		MHz
BW <sub>SS</sub>				2.3		MHz
GBWP	Gain Bandwidth Product			3.7		MHz
<b>Time Domain Response</b>						
$t_R, t_F$	Rise and Fall Time	$V_O=1.0\text{ V Step}$		300		ns
OS	Overshoot	$V_O=1.0\text{ V Step}$		5		%
SR	Slew Rate	$V_O=3\text{ V Step}, G=-1$		3		V/ $\mu$ s
<b>Distortion and Noise Response</b>						
HD2	2nd Harmonic Distortion	$V_O=1\text{ V}_{PP}, 10\text{ kHz}$		-80		dBc
HD3	3rd Harmonic Distortion	$V_O=1\text{ V}_{PP}, 10\text{ kHz}$		-80		dBc
THD	Total Harmonic Distortion	$V_O=1\text{ V}_{PP}, 10\text{ kHz}$		0.02		%
$e_n$	Input Voltage Noise			25		nV/ $\sqrt{\text{Hz}}$
<b>DC Performance</b>						
$V_{IO}$	Input Offset Voltage <sup>(3)</sup>		-8	0	+8	mV
$dV_{IO}$	Average Drift			2.9		$\mu\text{V}/^\circ\text{C}$
$I_{bn}$	Input Bias Current			5		pA
PSRR	Power Supply Rejection Ratio <sup>(3)</sup>	DC	50	73		dB
$A_{OL}$	Open-Loop Gain	DC		102		dB
$I_S$	Supply Current per Amplifier <sup>(3)</sup>			200	300	$\mu\text{A}$
<b>Input Characteristics</b>						
$R_{IN}$	Input Resistance			10		G $\Omega$
$C_{IN}$	Input Capacitance			1.2		pF
CMIR	Input Common Mode Voltage Range	Typical		-0.3 to 5.1		V
CMRR	Common Mode Rejection Ratio <sup>(3)</sup>	DC, $V_{CM}=0\text{ V to }V_S$	58	73		dB
<b>Output Characteristics</b>						
$V_O$	Output Voltage Swing <sup>(3)</sup>	$R_L=10\text{ k}\Omega$ to $V_S/2$	0.03	0.01 to 4.99	4.95	V
		$R_L=1\text{ k}\Omega$ to $V_S/2$		0.1 to 4.9		
$I_{SC}$	Short-Circuit Output Current			$\pm 33$		mA
$V_S$	Power Supply Operating Range			2.5 to 5.5		V

**Note:**

3. 100% tested at  $T_A=25^\circ\text{C}$ .

## Typical Performance Characteristics

$V_S=+2.7$ ,  $G=2$ ,  $R_L=10\text{ k}\Omega$  to  $V_S/2$ ,  $R_F=5\text{ k}\Omega$ ; unless otherwise noted.

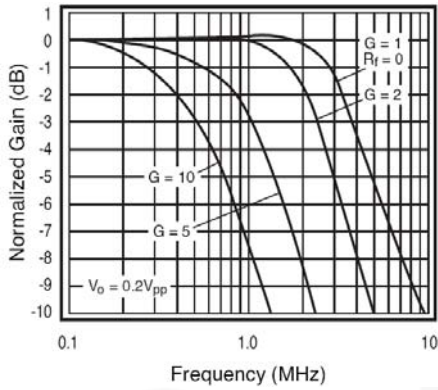

Figure 4. Non-Inverting Frequency Response (+5)

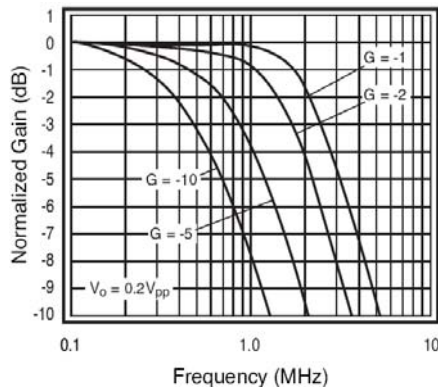

Figure 5. Inverting Frequency Response (+5 V)

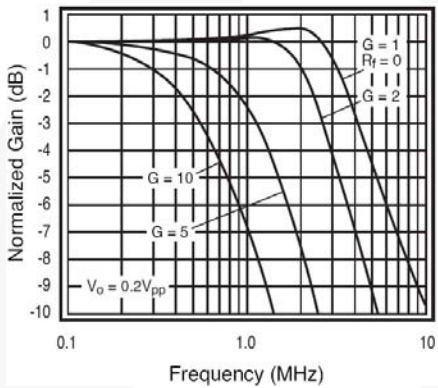

Figure 6. Non-Inverting Frequency Response

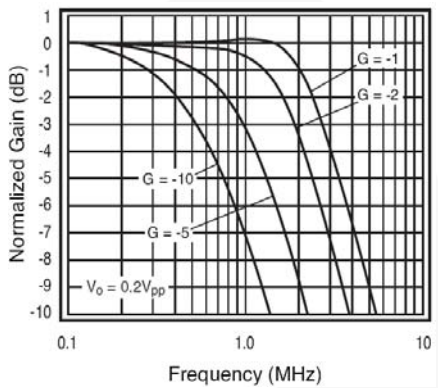

Figure 7. Inverting Frequency Response

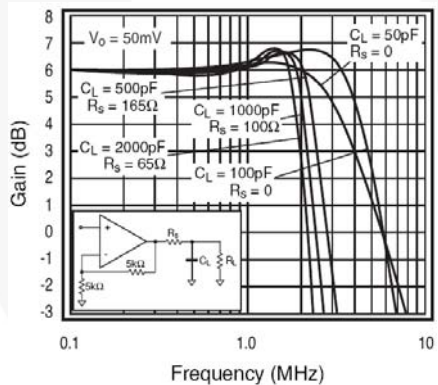

Figure 8. Frequency Response vs.  $C_L$

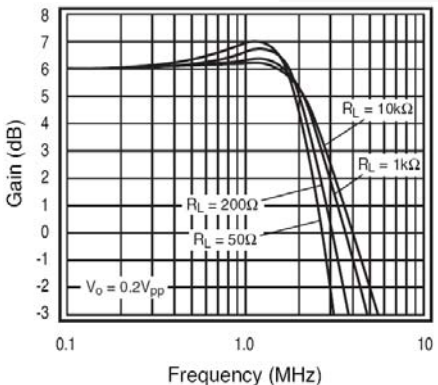

Figure 9. Frequency Response vs.  $R_L$

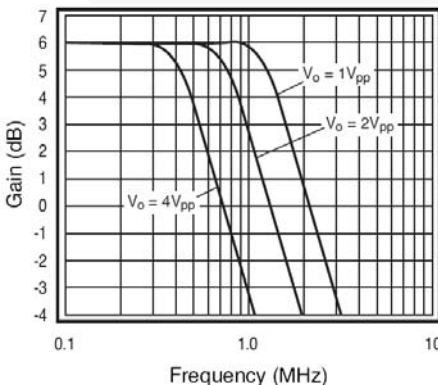

Figure 10. Large Signal Frequency Response (+5 V)

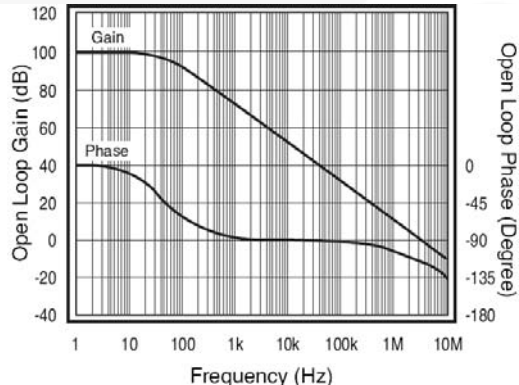

Figure 11. Open-Loop Gain and Phase vs. Frequency

## Typical Performance Characteristic

$V_S=+2.7$ ,  $G=2$ ,  $R_L=10\text{ k}\Omega$  to  $V_S/2$ ,  $R_F=5\text{ k}\Omega$ ; unless otherwise noted.

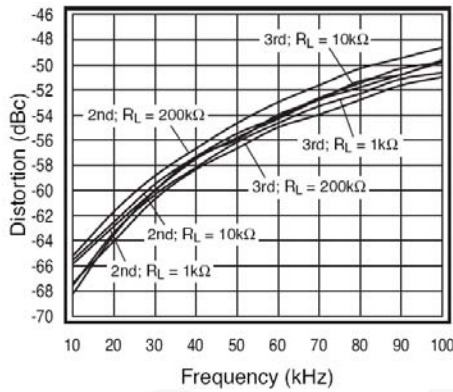

Figure 12. 2nd and 3rd Harmonic Distortion

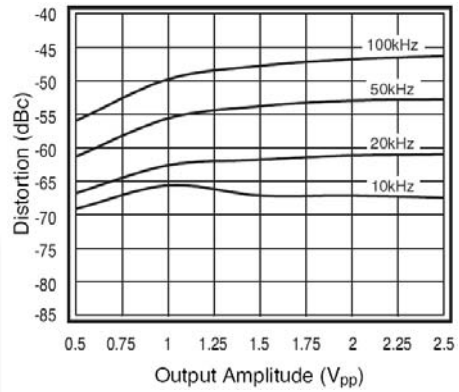

Figure 13. 2nd Harmonic Distortion vs.  $V_O$

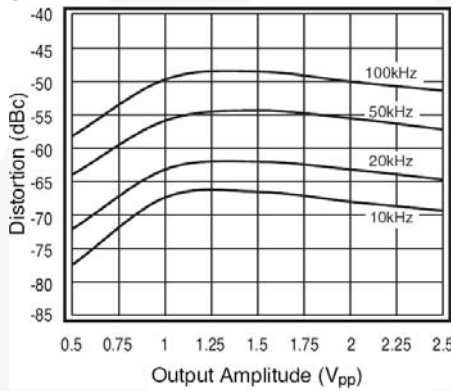

Figure 14. 3rd Harmonic Distortion vs.  $V_O$

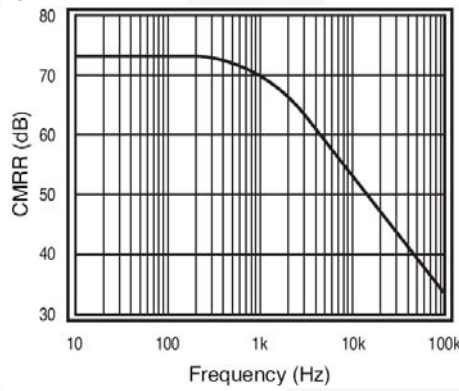

Figure 15. CMRR  $V_S=5\text{ V}$

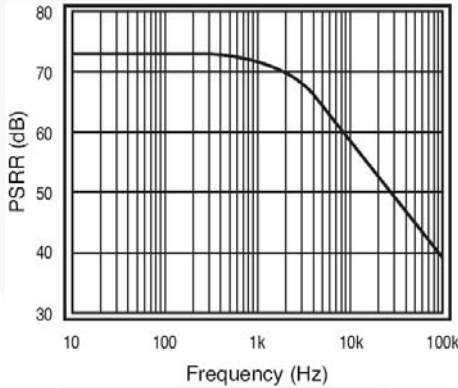

Figure 16. PSRR  $V_S=5\text{ V}$

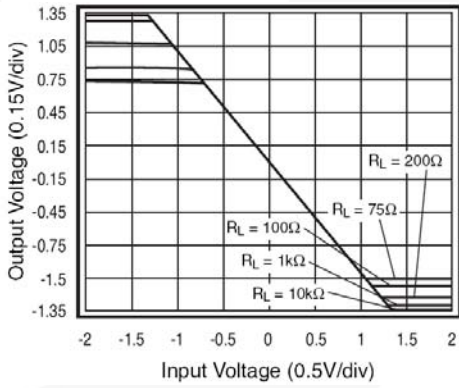

Figure 17. Output Swing vs. Load

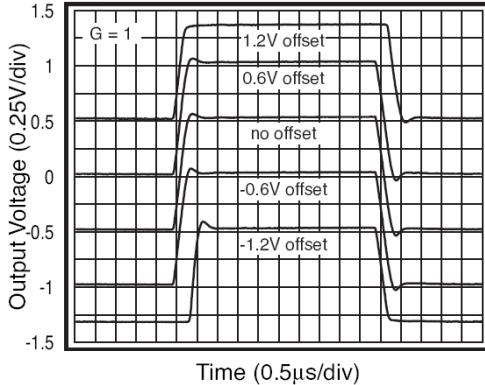

Figure 18. Pulse Response vs. Common-Mode Voltage

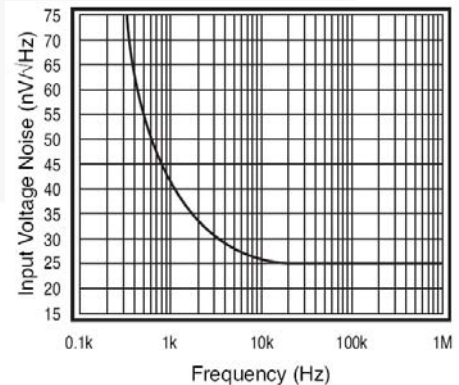

Figure 19. Input Voltage Noise



## Application Information

### General Description

The FAN4931 amplifier is a single-supply, general-purpose, voltage-feedback amplifier, fabricated on a bi-CMOS process. It features a rail-to-rail input and output and is unity gain stable. The typical non-inverting circuit schematic is shown in Figure 20.

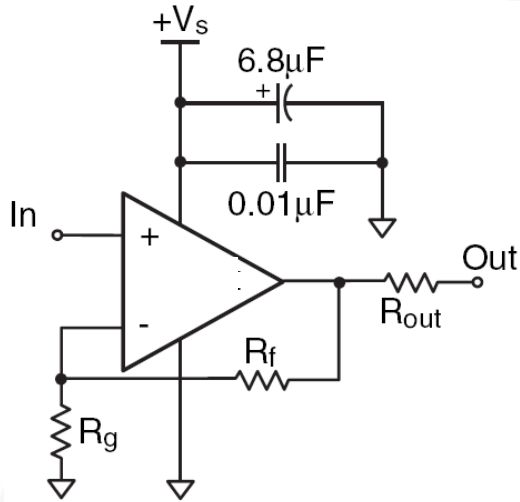

Figure 20. Typical Non-Inverting Configuration

### Input Common-Mode Voltage

The common-mode input range extends to 300 mV below ground and to 100 mV above  $V_S$  in single-supply operation. Exceeding these values does not cause phase reversal; however, if the input voltage exceeds the rails by more than 0.5 V, the input ESD devices begin to conduct. The output stays at the rail during this overdrive condition. If the absolute maximum input  $V_{IN}$  (700 mV beyond either rail) is exceeded, externally limit the input current to  $\pm 5$  mA, as shown in Figure 21.

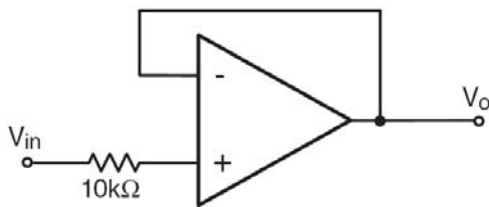

Figure 21. Circuit for Input Current Protection

### Power Dissipation

The maximum internal power dissipation allowed is directly related to the maximum junction temperature. If the maximum junction temperature exceeds 150°C, performance degradation occurs. If the maximum junction temperature exceeds 150°C for an extended time, device failure may occur.

### Overdrive Recovery

Overdrive of an amplifier occurs when the output and/or input ranges are exceeded. The recovery time varies based on whether the input or output is overdriven and by how much the range is exceeded. The FAN4931 typically recovers in less than 500 ns from an overdrive condition. Figure 22 shows the FAN4931 amplifier in an overdriven condition.

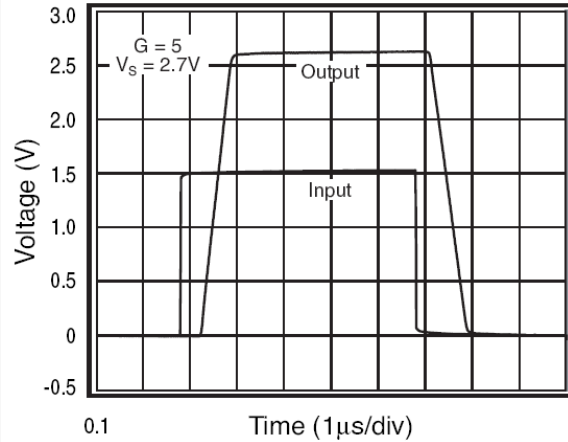

Figure 22. Overdrive Recovery

### Driving Capacitive Loads

Figure 8 illustrates the response of the amplifier. A small series resistance ( $R_S$ ) at the output, illustrated in Figure 23, improves stability and settling performance.  $R_S$  values in Figure 8 were chosen to achieve maximum bandwidth with less than 2 dB of peaking. For maximum flatness, use a larger  $R_S$ . Capacitive loads larger than 500 pF require the use of  $R_S$ .

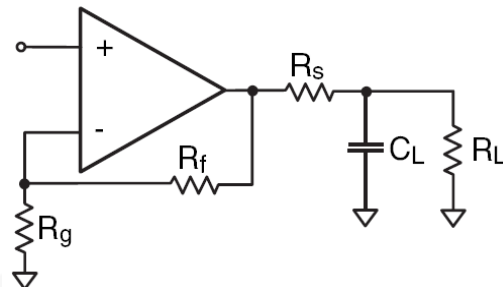

Figure 23. Typical Topology for Driving a Capacitive Load

Driving a capacitive load introduces phase-lag into the output signal, which reduces phase margin in the amplifier. The unity gain follower is the most sensitive configuration. In a unity gain follower configuration, the amplifier requires a 300  $\Omega$ -series resistor to drive a 100 pF load.

## Layout Considerations

General layout and supply bypassing play major roles in high-frequency performance. Fairchild evaluation boards help guide high-frequency layout and aid in device testing and characterization. Follow the steps below as a basis for high-frequency layout:

Include 6.8  $\mu\text{F}$  and 0.01  $\mu\text{F}$  ceramic capacitors.

Place the 6.8  $\mu\text{F}$  capacitor within 0.75 inches of the power pin.

Place the 0.01  $\mu\text{F}$  capacitor within 0.1 inches of the power pin.

Remove the ground plane under and around the part, especially near the input and output pins, to reduce parasitic capacitance.

Minimize all trace lengths to reduce series inductances.

Refer to the evaluation board layouts shown in Figure 24- Figure 26 for more information.

When evaluating only one channel, complete the following on the unused channel:

Ground the non-inverting input.

Short the output to the inverting input.

## Evaluation Board Information

The following evaluation board is available to aid in the testing and layout of this device.

Evaluation Board	Description	Products
FAN4931-011	Single-Channel, Dual-Supply, 5-Lead SC70	FAN4931IP5X

Evaluation board schematics are shown in Figure 24; layouts are shown in Figure 25-Figure 26.

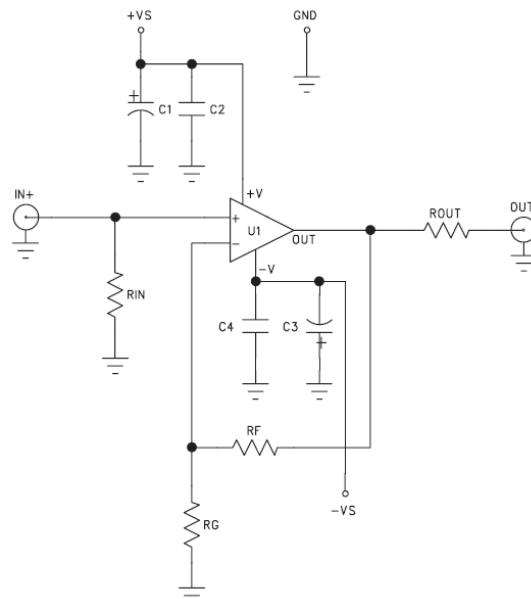

Figure 24. Evaluation Board Schematic

## Board Layout Information

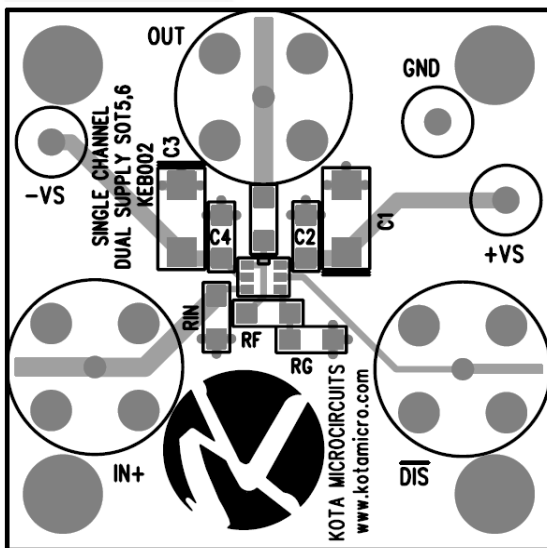

Figure 25. Top Side

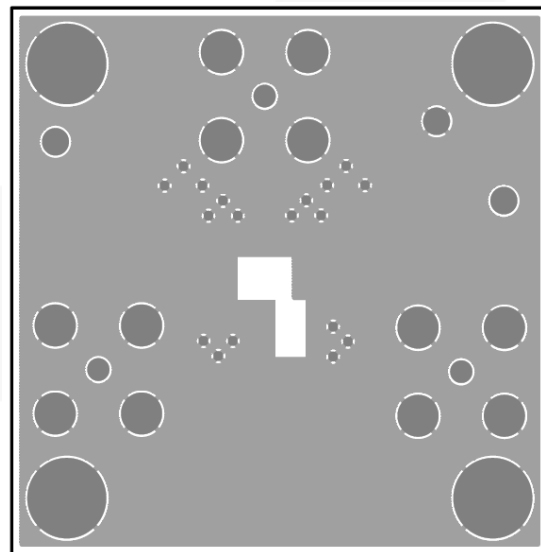
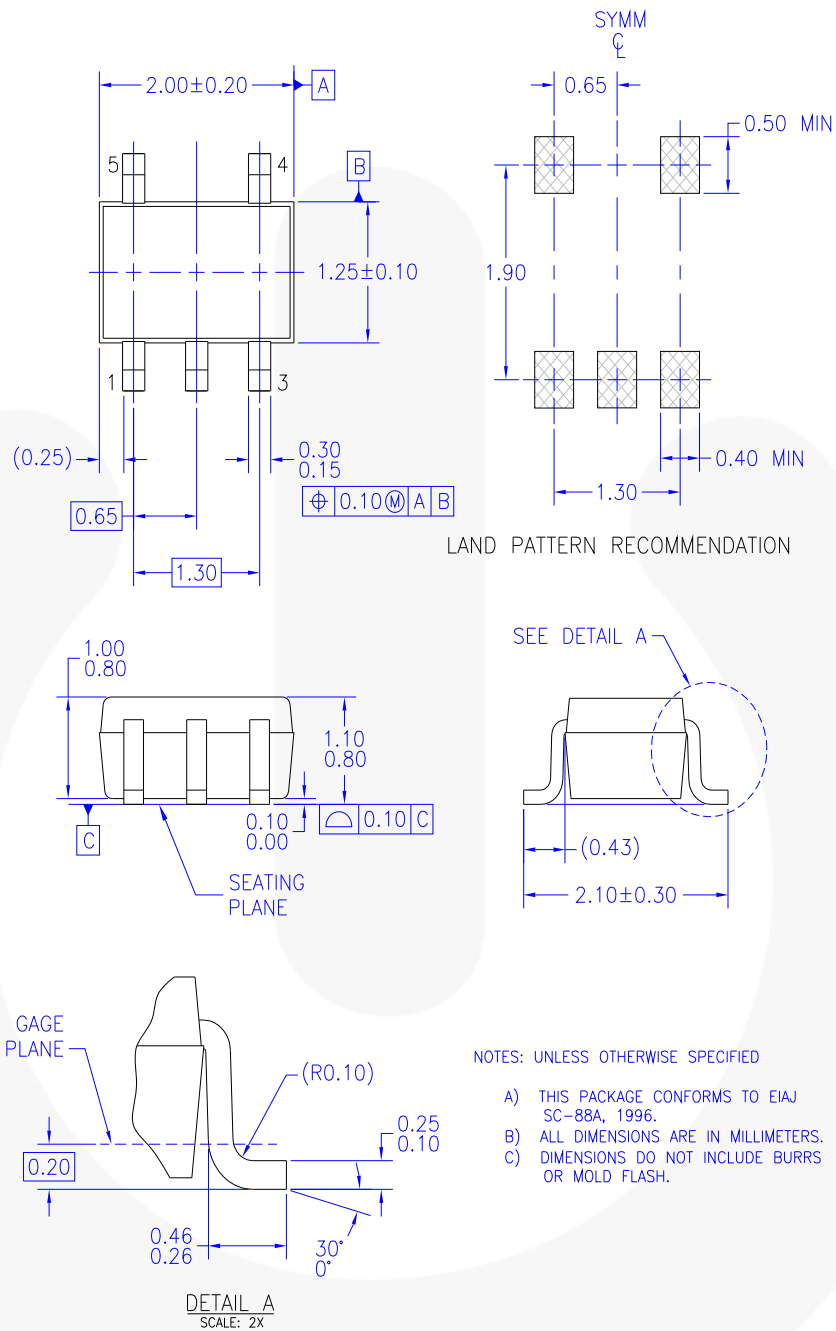

Figure 26. Bottom Side

Physical Dimensions



MAA05AREV5

Figure 27. 5-Lead SC70 Package

Package drawings are provided as a service to customers considering Fairchild components. Drawings may change in any manner without notice. Please note the revision and/or date on the drawing and contact a Fairchild Semiconductor representative to verify or obtain the most recent revision. Package specifications do not expand the terms of Fairchild's worldwide terms and conditions, specifically the warranty therein, which covers Fairchild products.

Always visit Fairchild Semiconductor's online packaging area for the most recent package drawings:  
<http://www.fairchildsemi.com/packaging/>.



**TRADEMARKS**

The following includes registered and unregistered trademarks and service marks, owned by Fairchild Semiconductor and/or its global subsidiaries, and is not intended to be an exhaustive list of all such trademarks.

- |   |  |   |   |
|---|--|---|---|
| 2Cool™  | FPS™   |  | Sync-Lock™  |
| AccuPower™  | F-PFS™   | PowerTrench®  |  |
| AX-CAP®*  | FRFET®   | PowerXS™  | TinyBoost™  |
| BitSIC™   | Global Power Resource™                         | Programmable Active Droop™  | TinyBuck™   |
| Build it Now™   | GreenBridge™                                   | QFET®   | TinyCalc™   |
| CorePLUS™   | Green FPS™                                     | QST™  | TinyLogic®  |
| CorePOWER™  | Green FPS™ e-Series™                           | Quiet Series™   | TINYOPTO™   |
| CROSSVOLT™  | Gmax™  | RapidConfigure™   | TinyPower™  |
| CTL™  | GTO™   |  | TinyPWM™  |
| Current Transfer Logic™   | IntelliMAX™                                    | Saving our world, 1mW/W at a time™  | TinyWire™   |
| DEUXPEED®   | ISOPLANAR™                                     | SignalWise™   | TranSIC™  |
| Dual Cool™  | Making Small Speakers Sound Louder and Better™ | SmartMax™   | TriFault Detect™  |
| EcoSPARK®   | MegaBuck™                                      | SMART START™  | TRUECURRENT®*   |
| EfficientMax™   | MICROCOUPLER™                                  | Solutions for Your Success™   | μSerDes™  |
| ESBC™   | MicroFET™                                      | SPM®  |  |
|  | MicroPak™                                      | STEALTH™  | UHC®  |
| Fairchild®  | MicroPak2™                                     | SuperFET®   | Ultra FRFET™  |
| Fairchild Semiconductor®  | MillerDrive™                                   | SuperSOT™-3   | UniFET™   |
| FACT Quiet Series™  | MotionMax™                                     | SuperSOT™-6   | VCM™  |
| FACT®   | mWSaver™                                       | SuperSOT™-8   | VisualMax™  |
| FAST®   | OptoHiT™                                       | SupreMOS®   | VoltagePlus™  |
| FastvCore™  | OPTOLOGIC®                                     | SyncFET™  | XST™  |
| FETBench™   | OPTOPLANAR®                                    |   |   |

\* Trademarks of System General Corporation, used under license by Fairchild Semiconductor.

**DISCLAIMER**

FAIRCHILD SEMICONDUCTOR RESERVES THE RIGHT TO MAKE CHANGES WITHOUT FURTHER NOTICE TO ANY PRODUCTS HEREIN TO IMPROVE RELIABILITY, FUNCTION, OR DESIGN. FAIRCHILD DOES NOT ASSUME ANY LIABILITY ARISING OUT OF THE APPLICATION OR USE OF ANY PRODUCT OR CIRCUIT DESCRIBED HEREIN, NEITHER DOES IT CONVEY ANY LICENSE UNDER ITS PATENT RIGHTS, NOR THE RIGHTS OF OTHERS. THESE SPECIFICATIONS DO NOT EXPAND THE TERMS OF FAIRCHILD'S WORLDWIDE TERMS AND CONDITIONS, SPECIFICALLY THE WARRANTY THEREIN, WHICH COVERS THESE PRODUCTS.

**LIFE SUPPORT POLICY**

FAIRCHILD'S PRODUCTS ARE NOT AUTHORIZED FOR USE AS CRITICAL COMPONENTS IN LIFE SUPPORT DEVICES OR SYSTEMS WITHOUT THE EXPRESS WRITTEN APPROVAL OF FAIRCHILD SEMICONDUCTOR CORPORATION.

As used herein:

- Life support devices or systems are devices or systems which, (a) are intended for surgical implant into the body or (b) support or sustain life, and (c) whose failure to perform when properly used in accordance with instructions for use provided in the labeling, can be reasonably expected to result in a significant injury of the user.
- A critical component in any component of a life support, device, or system whose failure to perform can be reasonably expected to cause the failure of the life support device or system, or to affect its safety or effectiveness.

**ANTI-COUNTERFEITING POLICY**

Fairchild Semiconductor Corporation's Anti-Counterfeiting Policy. Fairchild's Anti-Counterfeiting Policy is also stated on our external website, [www.fairchildsemi.com](http://www.fairchildsemi.com), under Sales Support.

Counterfeiting of semiconductor parts is a growing problem in the industry. All manufacturers of semiconductor products are experiencing counterfeiting of their parts. Customers who inadvertently purchase counterfeit parts experience many problems such as loss of brand reputation, substandard performance, failed applications, and increased cost of production and manufacturing delays. Fairchild is taking strong measures to protect ourselves and our customers from the proliferation of counterfeit parts. Fairchild strongly encourages customers to purchase Fairchild parts either directly from Fairchild or from Authorized Fairchild Distributors who are listed by country on our web page cited above. Products customers buy either from Fairchild directly or from Authorized Fairchild Distributors are genuine parts, have full traceability, meet Fairchild's quality standards for handling and storage, and provide access to Fairchild's full range of up-to-date technical and product information. Fairchild and our Authorized Distributors will stand behind all warranties and will appropriately address any warranty issues that may arise. Fairchild will not provide any warranty coverage or other assistance for parts bought from Unauthorized Sources. Fairchild is committed to combat this global problem and encourage our customers to do their part in stopping this practice by buying direct or from authorized distributors.

**PRODUCT STATUS DEFINITIONS**

**Definition of Terms**

Datasheet Identification	Product Status	Definition
Advance Information	Formative / In Design	Datasheet contains the design specifications for product development. Specifications may change in any manner without notice.
Preliminary	First Production	Datasheet contains preliminary data; supplementary data will be published at a later date. Fairchild Semiconductor reserves the right to make changes at any time without notice to improve design.
No Identification Needed	Full Production	Datasheet contains final specifications. Fairchild Semiconductor reserves the right to make changes at any time without notice to improve the design.
Obsolete	Not In Production	Datasheet contains specifications on a product that is discontinued by Fairchild Semiconductor. The datasheet is for reference information only.

Rev. I64

ON Semiconductor and  are trademarks of Semiconductor Components Industries, LLC dba ON Semiconductor or its subsidiaries in the United States and/or other countries. ON Semiconductor owns the rights to a number of patents, trademarks, copyrights, trade secrets, and other intellectual property. A listing of ON Semiconductor's product/patent coverage may be accessed at [www.onsemi.com/site/pdf/Patent-Marking.pdf](http://www.onsemi.com/site/pdf/Patent-Marking.pdf). ON Semiconductor reserves the right to make changes without further notice to any products herein. ON Semiconductor makes no warranty, representation or guarantee regarding the suitability of its products for any particular purpose, nor does ON Semiconductor assume any liability arising out of the application or use of any product or circuit, and specifically disclaims any and all liability, including without limitation special, consequential or incidental damages. Buyer is responsible for its products and applications using ON Semiconductor products, including compliance with all laws, regulations and safety requirements or standards, regardless of any support or applications information provided by ON Semiconductor. "Typical" parameters which may be provided in ON Semiconductor data sheets and/or specifications can and do vary in different applications and actual performance may vary over time. All operating parameters, including "Typicals" must be validated for each customer application by customer's technical experts. ON Semiconductor does not convey any license under its patent rights nor the rights of others. ON Semiconductor products are not designed, intended, or authorized for use as a critical component in life support systems or any FDA Class 3 medical devices or medical devices with a same or similar classification in a foreign jurisdiction or any devices intended for implantation in the human body. Should Buyer purchase or use ON Semiconductor products for any such unintended or unauthorized application, Buyer shall indemnify and hold ON Semiconductor and its officers, employees, subsidiaries, affiliates, and distributors harmless against all claims, costs, damages, and expenses, and reasonable attorney fees arising out of, directly or indirectly, any claim of personal injury or death associated with such unintended or unauthorized use, even if such claim alleges that ON Semiconductor was negligent regarding the design or manufacture of the part. ON Semiconductor is an Equal Opportunity/Affirmative Action Employer. This literature is subject to all applicable copyright laws and is not for resale in any manner.

## PUBLICATION ORDERING INFORMATION

### LITERATURE FULFILLMENT:

Literature Distribution Center for ON Semiconductor  
19521 E. 32nd Pkwy, Aurora, Colorado 80011 USA  
**Phone:** 303-675-2175 or 800-344-3860 Toll Free USA/Canada  
**Fax:** 303-675-2176 or 800-344-3867 Toll Free USA/Canada  
**Email:** [orderlit@onsemi.com](mailto:orderlit@onsemi.com)

**N. American Technical Support:** 800-282-9855 Toll Free  
USA/Canada  
**Europe, Middle East and Africa Technical Support:**  
Phone: 421 33 790 2910  
**Japan Customer Focus Center**  
Phone: 81-3-5817-1050

**ON Semiconductor Website:** [www.onsemi.com](http://www.onsemi.com)  
**Order Literature:** <http://www.onsemi.com/orderlit>  
For additional information, please contact your local  
Sales Representative