

1 Form A Solid-State Relay

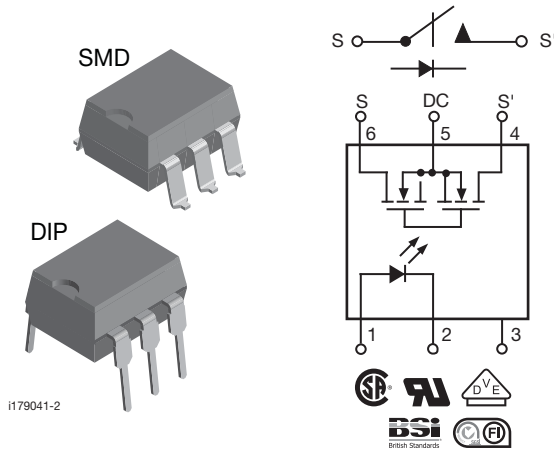

DESCRIPTION

The LH1540 is robust, ideal for telecom and ground fault applications. It is an SPST normally open switch (form A) that replaces electromechanical relays in many applications. It is constructed using a GaAlAs LED for actuation control and an integrated monolithic die for the switch output. The die, fabricated in a high-voltage dielectrically isolated technology, is comprised of a photodiode array, switch control circuitry and MOSFET switches. In addition, it employs current-limiting circuitry which meets lightning surge testing as per ANSI/TIA-968-B and other regulatory voltage surge requirements when overvoltage protection is provided.

FEATURES

- Current limit protection
- Isolation test voltage 5300 V_{RMS}
- Typical R_{ON} 20 Ω, max. 25 Ω
- Load voltage 350 V
- Load current 120 mA
- High surge capability
- Clean bounce free switching
- Low power consumption
- SMD lead available on tape and reel
- Compliant to RoHS Directive 2002/95/EC and in accordance to WEEE 2002/96/EC



RoHS
COMPLIANT

APPLICATIONS

- General telecom switching
- Instrumentation
- Industrial controls

Note

- See “solid-state relays” (application note 56)

AGENCY APPROVALS

UL1577: file no. E52744 system code H, double protection
 CSA: certification no. 093751
 BSI: certification no. 7979/7980
 FIMKO: 25419
 DIN EN: 60747-5-2 (VDE 0884)/60747-5-5 (pending), available with option 1

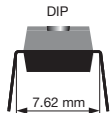
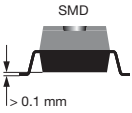
ORDERING INFORMATION													
L	H	1	5	4	0	#	#	#	T	R	 DIP 7.62 mm	 SMD > 0.1 mm	
PART NUMBER						ELECTR. VARIATION		PACKAGE CONFIG.		TAPE AND REEL			
PACKAGE						UL, CSA, BSI, FIMKO							
SMD-6						LH1540AAB							
SMD-6, tape and reel						LH1540AABTR							
DIP-6, thru hole						LH1540AT							



ABSOLUTE MAXIMUM RATINGS ($T_{amb} = 25\text{ }^{\circ}\text{C}$, unless otherwise specified)				
PARAMETER	TEST CONDITION	SYMBOL	VALUE	UNIT
INPUT				
LED continuous forward current		I_F	50	mA
LED reverse voltage	$I_R \leq 10\text{ }\mu\text{A}$	V_R	8	V
OUTPUT				
DC or peak AC load voltage	$I_L \leq 50\text{ }\mu\text{A}$	V_L	350	V
Continuous DC load current - bidirectional operation		I_L	120	mA
Continuous DC load current - unidirectional operation		I_L	250	mA
Peak load current (single shot)	$t = 100\text{ ms}$	I_P	(1)	mA
SSR				
Ambient temperature range		T_{amb}	- 40 to + 85	$^{\circ}\text{C}$
Storage temperature range		T_{stg}	- 40 to + 150	$^{\circ}\text{C}$
Pin soldering temperature (2)	$t = 10\text{ s max.}$	T_{sld}	260	$^{\circ}\text{C}$
Input to output isolation voltage		V_{ISO}	5300	V_{RMS}
Output power dissipation (continuous)		P_{diss}	550	mW

Notes

- Stresses in excess of the absolute maximum ratings can cause permanent damage to the device. Functional operation of the device is not implied at these or any other conditions in excess of those given in the operational sections of this document. Exposure to absolute maximum ratings for extended periods of the time can adversely affect reliability.

(1) Refer to current limit performance application note for a discussion on relay operation during transient currents.

(2) Refer to reflow profile for soldering conditions for surface mounted devices (SMD). Refer to wave profile for soldering conditions for through hole devices (DIP).

ELECTRICAL CHARACTERISTICS ($T_{amb} = 25\text{ }^{\circ}\text{C}$, unless otherwise specified)						
PARAMETER	TEST CONDITION	SYMBOL	MIN.	TYP.	MAX.	UNIT
INPUT						
LED forward current, switch turn-on	$I_L = 100\text{ mA}$, $t = 10\text{ ms}$	I_{Fon}		1	2	mA
LED forward current, switch turn-off	$V_L = \pm 300\text{ V}$	I_{Foff}	0.2	0.9		mA
LED forward voltage	$I_F = 10\text{ mA}$	V_F	1.15	1.26	1.45	V
OUTPUT						
On-resistance AC/DC: pin 4 (\pm) to 6 (\pm)	$I_F = 5\text{ mA}$, $I_L = 50\text{ mA}$	R_{ON}	12	20	25	Ω
On-resistance DC: pin 4, 6 (+) to 5 (\pm)	$I_F = 5\text{ mA}$, $I_L = 100\text{ mA}$	R_{ON}	3	5	6.25	Ω
Off-resistance	$I_F = 0\text{ mA}$, $V_L = \pm 100\text{ V}$	R_{OFF}	0.5	5000		$G\Omega$
Current limit AC (1): pin 4 (\pm) to 6 (\pm)	$I_F = 5\text{ mA}$, $V_L = \pm 6\text{ V}$, $t = 5\text{ ms}$	I_{LMT}	175	210	250	mA
Off-state leakage current	$I_F = 0\text{ mA}$, $V_L = \pm 100\text{ V}$	I_O		0.32	200	nA
	$I_F = 0\text{ mA}$, $V_L = \pm 350\text{ V}$	I_O			1	μA
Output capacitance pin 4 to 6	$I_F = 0\text{ mA}$, $V_L = 1\text{ V}$	C_O		55		pF
	$I_F = 0\text{ mA}$, $V_L = 50\text{ V}$	C_O		10		pF
Switch offset	$I_F = 5\text{ mA}$	V_{OS}		0.15		μV
TRANSFER						
Capacitance (input to output)	$V_{ISO} = 1\text{ V}$	C_{IO}		0.8		pF

Notes

- Minimum and maximum values are testing requirements. Typical values are characteristics of the device and are the result of engineering evaluations. Typical values are for information only and are not part of the testing requirements.

(1) No DC mode current limit available.

SWITCHING CHARACTERISTICS ($T_{amb} = 25\text{ }^{\circ}\text{C}$, unless otherwise specified)						
PARAMETER	TEST CONDITION	SYMBOL	MIN.	TYP.	MAX.	UNIT
Turn-on time	$I_F = 5\text{ mA}$, $I_L = 50\text{ mA}$	t_{on}		1.2	2	ms
Turn-off time	$I_F = 5\text{ mA}$, $I_L = 50\text{ mA}$	t_{off}		0.5	2	ms



SAFETY AND INSULATION RATINGS				
PARAMETER	TEST CONDITION	SYMBOL	VALUE	UNIT
Climatic classification	IEC 68 part 1		40/85/21	
Pollution degree	DIN VDE 0109		2	
Tracking resistance (comparative tracking index)	Insulation group IIIa	CTI	175	
Highest allowable overvoltage	Transient overvoltage	V_{IOTM}	8000	V_{peak}
Max. working insulation voltage	Recurring peak voltage	V_{IORM}	890	V_{peak}
Insulation resistance at 25 °C	$V_{IO} = 500 V$	R_{IS}	$\geq 10^{12}$	Ω
Insulation resistance at T_S		R_{IS}	$\geq 10^9$	Ω
Insulation resistance at 100 °C		R_{IS}	$\geq 10^{11}$	Ω
Partial discharge test voltage	Method e a, $V_{pd} = V_{IORM} \times 1.875$	V_{pd}	1669	V_{peak}
Safety limiting values - maximum values allowed in the event of a failure	Case temperature	T_{SI}	175	°C
	Input current	I_{SI}	300	mA
	Output power	P_{SO}	700	mW
Minimum external air gap (clearance)	Measured from input terminals to output terminals, shortest distance through air		≥ 7	mm
Minimum external tracking (creepage)	Measured from input terminals to output terminals, shortest distance path along body		≥ 7	mm

TYPICAL CHARACTERISTICS ($T_{amb} = 25\text{ °C}$, unless otherwise specified)



Fig. 1 - Recommended Operating Conditions

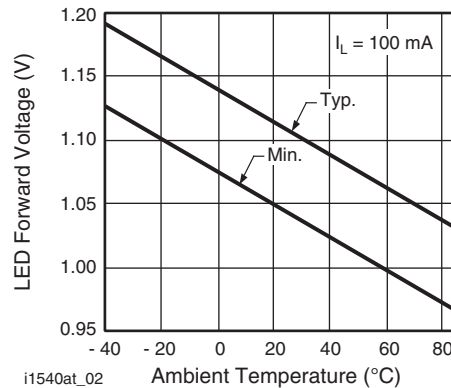

Fig. 3 - LED Dropout Voltage vs. Temperature

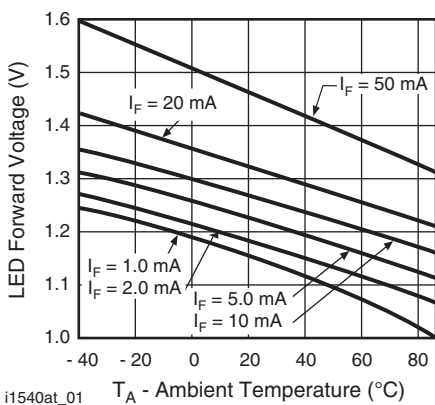

Fig. 2 - LED Voltage vs. Temperature

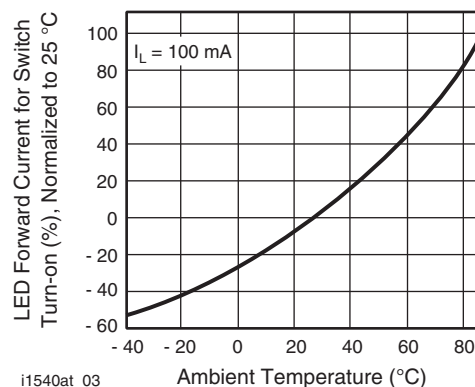

Fig. 4 - LED Current for Switch Turn-on vs. Temperature

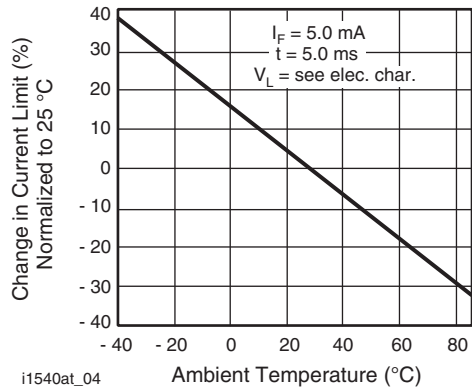

Fig. 5 - Current Limit vs. Temperature

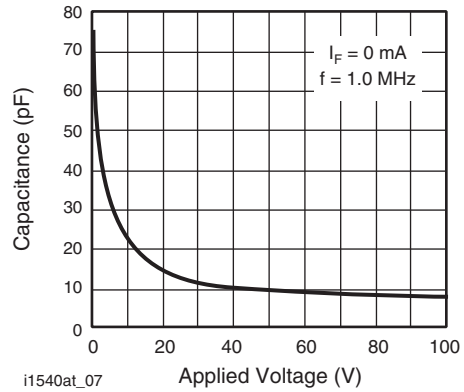

Fig. 8 - Switch Capacitance vs. Applied Voltage

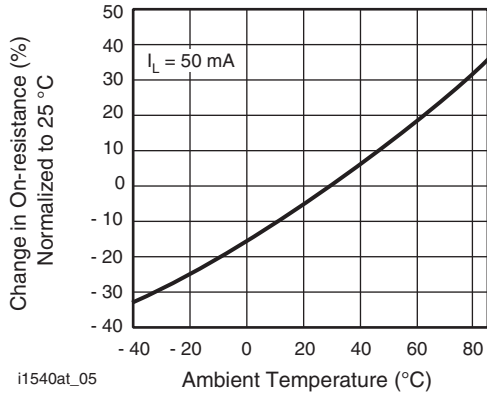

Fig. 6 - On-resistance vs. Temperature

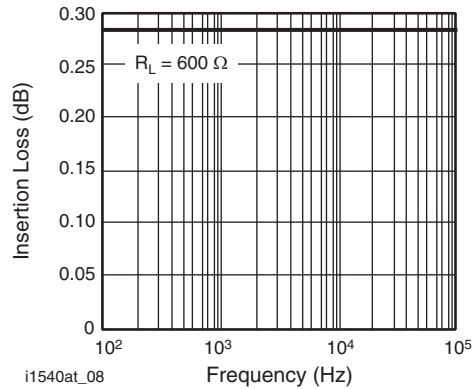

Fig. 9 - Insertion Loss vs. Frequency

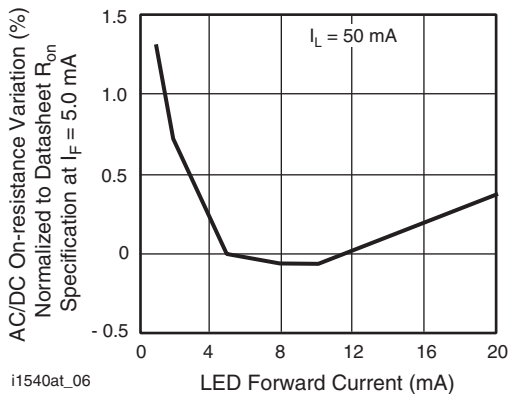

Fig. 7 - Variation in On-resistance vs. LED Current

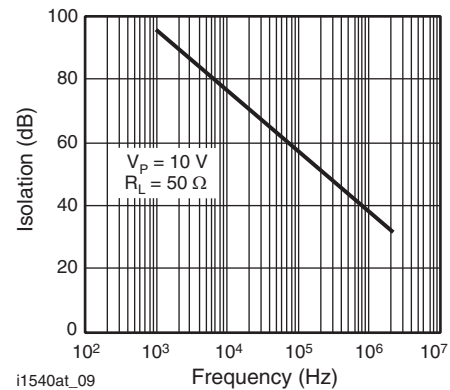

Fig. 10 - Output Isolation



Fig. 11 - Leakage Current vs. Applied Voltage

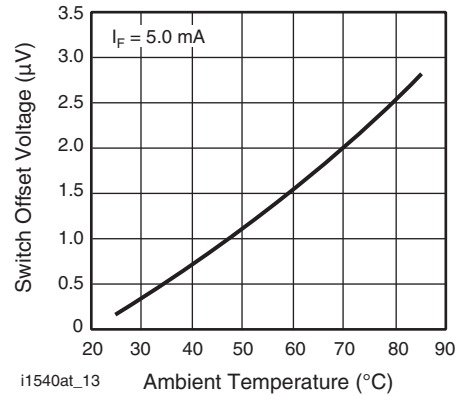

Fig. 14 - Switch Offset Voltage vs. Temperature



Fig. 12 - Leakage Current vs. Applied Voltage at Elevated Temperatures

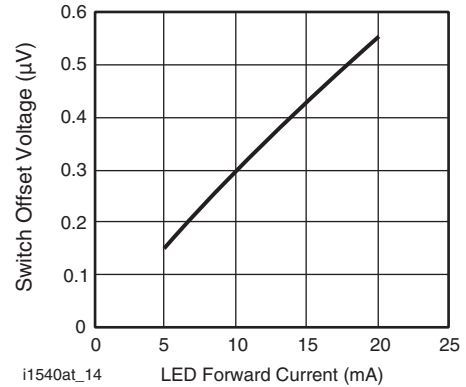

Fig. 15 - Switch Offset Voltage vs. LED Current

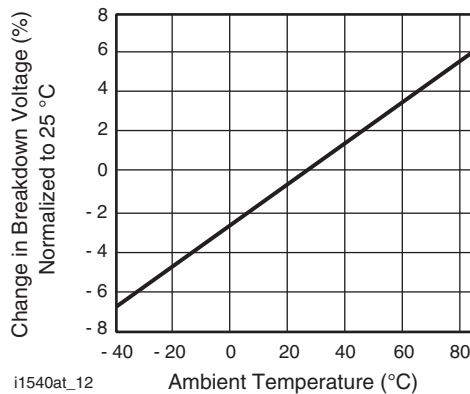

Fig. 13 - Switch Breakdown Voltage vs. Temperature

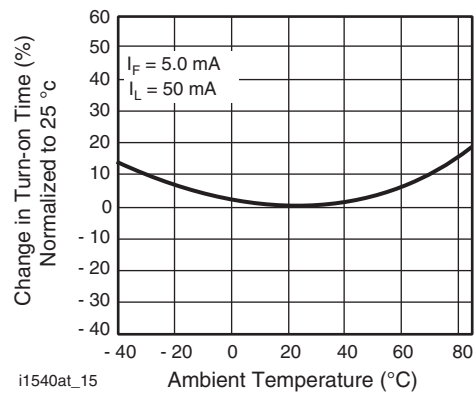

Fig. 16 - Turn-on Time vs. Temperature

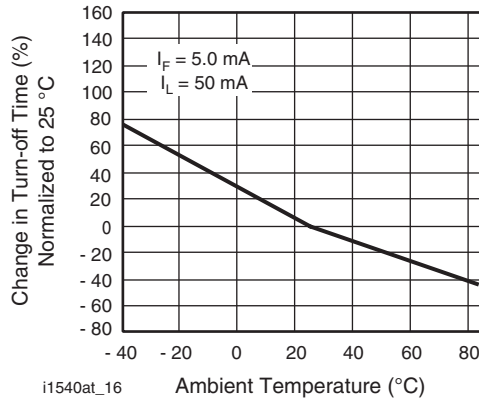

Fig. 17 - Turn-off Time vs. Temperature

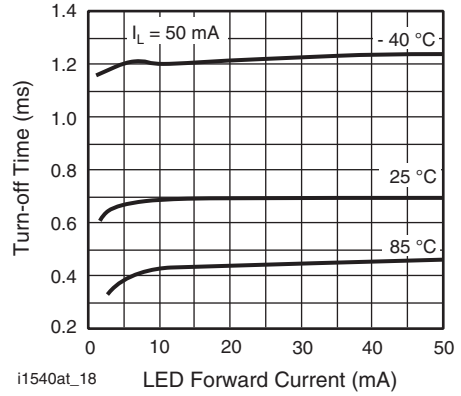

Fig. 19 - Turn-off Time vs. LED Current

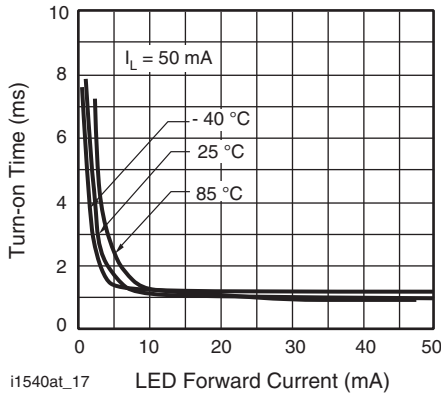
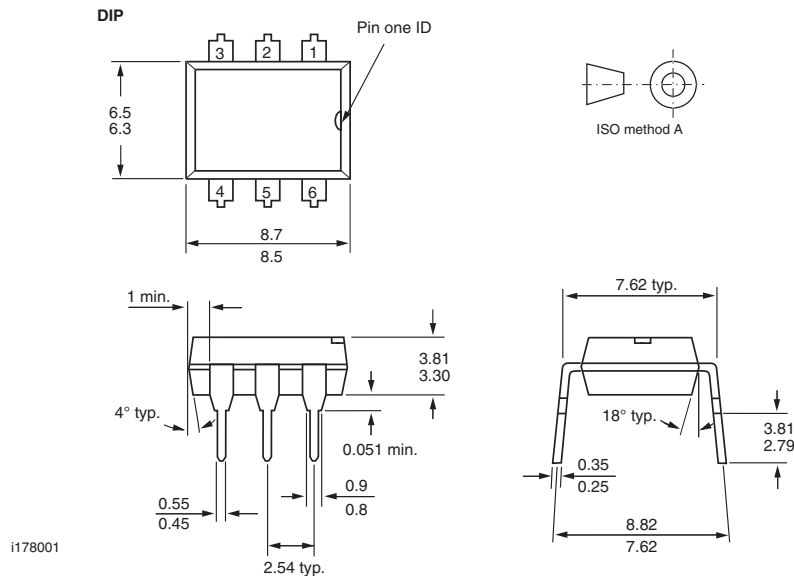

Fig. 18 - Turn-on Time vs. LED Current

PACKAGE DIMENSIONS in millimeters





PACKAGE MARKING



Note

- Tape and reel suffix (TR) is not part of the package marking.



Footprint and Schematic Information for LH1540

The footprint and schematic symbols for the following parts can be accessed using the associated links. They are available in Eagle, Altium, KiCad, OrCAD / Allegro, Pulsonix, and PADS.

Note that the 3D models for these parts can be found on the Vishay product page.

PART NUMBER	FOOTPRINT / SCHEMATIC
LH1540AAB	www.snapeda.com/parts/LH1540AAB/Vishay/view-part
LH1540AABTR	www.snapeda.com/parts/LH1540AABTR/Vishay/view-part
LH1540ACD	www.snapeda.com/parts/LH1540ACD/Vishay/view-part
LH1540ACDTR	www.snapeda.com/parts/LH1540ACDTR/Vishay/view-part
LH1540AT	www.snapeda.com/parts/LH1540AT/Vishay/view-part

For technical issues and product support, please contact optocoupleranswers@vishay.com.

SMD

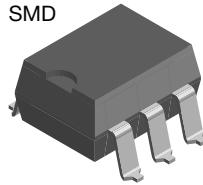

DIP

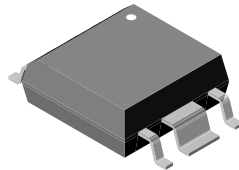
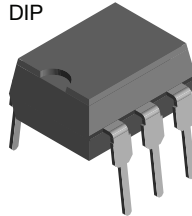



Disclaimer

ALL PRODUCT, PRODUCT SPECIFICATIONS AND DATA ARE SUBJECT TO CHANGE WITHOUT NOTICE TO IMPROVE RELIABILITY, FUNCTION OR DESIGN OR OTHERWISE.

Vishay Intertechnology, Inc., its affiliates, agents, and employees, and all persons acting on its or their behalf (collectively, "Vishay"), disclaim any and all liability for any errors, inaccuracies or incompleteness contained in any datasheet or in any other disclosure relating to any product.

Vishay makes no warranty, representation or guarantee regarding the suitability of the products for any particular purpose or the continuing production of any product. To the maximum extent permitted by applicable law, Vishay disclaims (i) any and all liability arising out of the application or use of any product, (ii) any and all liability, including without limitation special, consequential or incidental damages, and (iii) any and all implied warranties, including warranties of fitness for particular purpose, non-infringement and merchantability.

Statements regarding the suitability of products for certain types of applications are based on Vishay's knowledge of typical requirements that are often placed on Vishay products in generic applications. Such statements are not binding statements about the suitability of products for a particular application. It is the customer's responsibility to validate that a particular product with the properties described in the product specification is suitable for use in a particular application. Parameters provided in datasheets and / or specifications may vary in different applications and performance may vary over time. All operating parameters, including typical parameters, must be validated for each customer application by the customer's technical experts. Product specifications do not expand or otherwise modify Vishay's terms and conditions of purchase, including but not limited to the warranty expressed therein.

Except as expressly indicated in writing, Vishay products are not designed for use in medical, life-saving, or life-sustaining applications or for any other application in which the failure of the Vishay product could result in personal injury or death. Customers using or selling Vishay products not expressly indicated for use in such applications do so at their own risk. Please contact authorized Vishay personnel to obtain written terms and conditions regarding products designed for such applications.

No license, express or implied, by estoppel or otherwise, to any intellectual property rights is granted by this document or by any conduct of Vishay. Product names and markings noted herein may be trademarks of their respective owners.