

Product	Polzahl: 14, Flanschdose, löten, 12 - 19 pol, vergoldete Kontakte, mit UL-Zulassung
Area	M16 IP67 Series 423/ 723/ 425
Article number	09 0454 00 14

Illustration

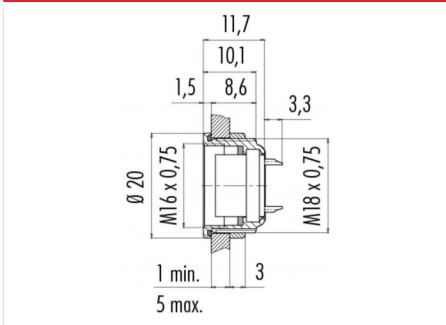

Scale drawing



Contact Arrangement

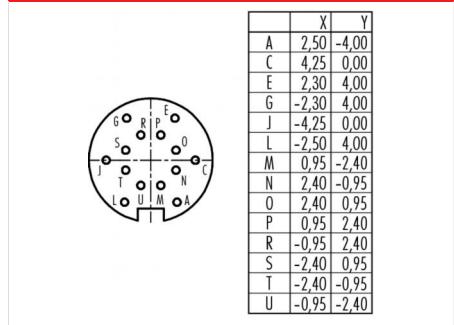

You can find the assembly instruction on the next page.

Technical data

General features

Connector Design	female panel mount connector
Connector locking system	bolted
Termination	solder
Wire gauge (mm)	0,25 mm ²
Wire gauge (AWG)	24
Upper temperature	95 °C
Lower temperature	-40 °C

Cable data

Approval 1	UL
------------	----

Electrical parameters

Rated voltage	60 V
Rated impulse voltage	500 V
Pollution degree	1
Overvoltage category	I
Material group	III
Rated current (40°C)	3 A
Volume resistivity	≤ 3 mΩ
EMV compliance	shielded
Degree of protection	IP67

Material

Material of contact	CuSn (Bronze)
Contact plating	Au (gold)
Material of contact body	PBT (UL 94 V-0)

Product	Polzahl: 14, Flanschdose, löten, 12 - 19 pol, vergoldete Kontakte, mit UL-Zulassung
Area	M16 IP67 Series 423/ 723/ 425
Article number	09 0454 00 14

Installation instructions / Mounting cutout

