



M18 Automatisierungstechnik - Sonder M18 Automation Technology - Special

Kabelsteckverbinder

- Schraubverriegelung M18
- Schutzart IP67 ¹⁾
- Einfache Montage
- Schraubklemmanschluss
- Winkelsteckverbinder in 4 Positionen einstellbar

Flanschsteckverbinder

- Schraubverriegelung M18
- Schutzart IP67 ¹⁾
- Einfache Montage
- Löt-/Tauchlötanschluss
- Verschiedene Bauformen

Cable Connectors

- Screw locking M18
- Degree of protection IP67 ¹⁾
- Easy assembly
- Screw clamp connection
- Angled connector adjustable in 4 positions

Panel Mount Connectors

- Screw locking M18
- Degree of protection IP67 ¹⁾
- Easy assembly
- Solder/dip solder termination
- Various variants

¹⁾ Erläuterung der Schutzarten siehe technische Informationen. / ¹⁾ Explanation of protection standards see technical information.

Kabeldose
Female cable connector

Abbildung / Figure



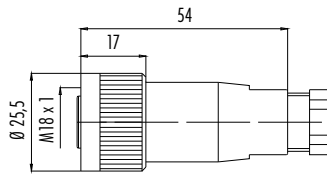

Maßzeichnung / Drawing

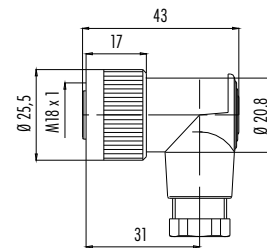

Winkeldose
Female angled connector



Bestell-Daten / Order Data

Polzahl Contacts	Kabeldurchlass Cable outlet	Bestell-Nr. Ordering-No.
4	6,5–8 mm	09 0440 10 04
		09 0440 010 04 
	10–12 mm	99 0440 16 04
		99 0440 016 04 

Polzahl Contacts	Kabeldurchlass Cable outlet	Bestell-Nr. Ordering-No.
4	6,5–8 mm	09 0440 00 04
		09 0440 000 04 

Technische Daten / Specifications

Polzahl	4	Number of contacts
Steckverbinder Verriegelung	schrauben/screw	Connector locking system
Anschlussart	schrauben/screw	Termination
Anschlussquerschnitt	max. 1,5 mm ² (max. AWG 16)	Wire gauge
Kabeldurchlass	6,5–8 mm, 10–12 mm	Cable outlet
Schutzart	IP67	Degree of protection
Mechanische Lebensdauer	> 50 Steckzyklen/> 50 mating cycles	Mechanical operation
Obere Grenztemperatur	+ 85 °C	Upper temperature
Untere Grenztemperatur	– 25 °C	Lower temperature
Bemessungsspannung	250 V	Rated voltage
Bemessungs-Stoßspannung	4000 V	Rated impulse voltage
Verschmutzungsgrad	3	Pollution degree
Überspannungskategorie	III	Overvoltage categorie
Isolierstoffgruppe	III	Material group
Bemessungsstrom (40°C)	16 A/cUR 5 A	Rated current (40 °C)
Durchgangswiderstand	≤ 8 mΩ	Contact resistance
Material Kontakt	CuZn (Messing/brass)	Material of contact
Kontaktoberfläche	CuSnZn (Optalloy/optalloy)	Contact plating
Material Kontaktkörper	PA/PBT	Material of contact body
Material Gehäuse	PA/PBT	Material of housing

Einbaustecker, löten, transparent
Male receptacle, solder, transparent

Adapterstecker, löten, transparent
Male adapter, solder, transparent

Abbildung / Figure



Maßzeichnung / Drawing

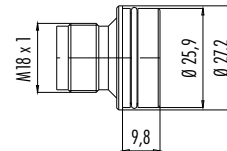
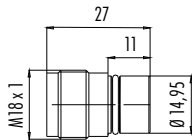

Bestell-Daten / Order Data

Polzahl Contacts	Ohne Vergussloch Without sealing hole	Mit Vergussloch With sealing hole
4	09 0441 00 04	09 0441 50 04

Polzahl Contacts	Ohne Vergussloch Without sealing hole	Mit Vergussloch With sealing hole
4	09 0443 00 04	09 0443 50 04

Technische Daten / Specifications

Polzahl	4	Number of contacts
Steckverbinder Verriegelung	Schrauben/screw	Connector locking system
Anschlussart	löten/solder	Termination
Anschlussquerschnitt	max. 1,5 mm ² (max. AWG 16)	Wire gauge
Kabeldurchlass	—	Cable outlet
Schutzart	IP67	Degree of protection
Mechanische Lebensdauer	> 50 Steckzyklen/> 50 mating cycles	Mechanical operation
Obere Grenztemperatur	+ 85 °C	Upper temperature
Untere Grenztemperatur	- 25 °C	Lower temperature
Bemessungsspannung	250 V	Rated voltage
Bemessungs-Stoßspannung	4000 V	Rated impulse voltage
Verschmutzungsgrad	3	Pollution degree
Überspannungskategorie	III	Overvoltage categorie
Isolierstoffgruppe	II	Material group
Bemessungsstrom (40°C)	16 A	Rated current (40 °C)
Durchgangswiderstand	≤ 8 mΩ	Contact resistance
Material Kontakt	CuZn (Messing/brass)	Material of contact
Kontaktoberfläche	CuSnZn (Optalloy/optalloy)	Contact plating
Material Kontaktkörper	PA	Material of contact body
Material Gehäuse	PA	Material of housing

Flanschstecker, löten, mit Befestigungsgewinde
Male panel mount connector, solder, with fixing thread

Abbildung / Figure



Maßzeichnung / Drawing

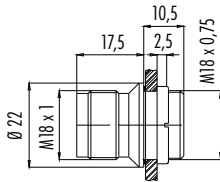

Flanschstecker, von vorn verschraubbar, tauchlöten
Male panel mount connector, front fastened, dip solder

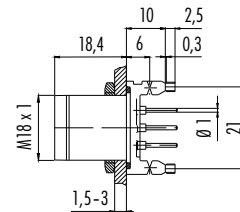

Bestell-Daten / Order Data

Polzahl Contacts	Bestell-Nr. Ordering-No.
4	09 0441 81 04
	09 0440 081 04 

Polzahl Contacts	Bestell-Nr. Ordering-No.
4	09 0441 90 04
	09 0440 090 04 

Technische Daten / Specifications

Polzahl	4	Number of contacts
Steckverbinder Verriegelung	schrauben/screw	Connector locking system
Anschlussart	löten, tauchlöten/solder, dip solder	Termination
Anschlussquerschnitt	max. 1,5 mm ² (max. AWG 16)	Wire gauge
Kabeldurchlass	—	Cable outlet
Schutzart	IP67	Degree of protection
Mechanische Lebensdauer	> 50 Steckzyklen/> 50 mating cycles	Mechanical operation
Obere Grenztemperatur	+ 85 °C	Upper temperature
Untere Grenztemperatur	- 25 °C	Lower temperature
Bemessungsspannung	250 V	Rated voltage
Bemessungs-Stoßspannung	4000 V	Rated impulse voltage
Verschmutzungsgrad	3	Pollution degree
Überspannungskategorie	III	Overvoltage categorie
Isolierstoffgruppe	III	Material group
Bemessungsstrom (40°C)	16 A, 5 A tauchlöten/dip solder, cUR 5 A	Rated current (40 °C)
Durchgangswiderstand	≤ 8 mΩ	Contact resistance
Material Kontakt	CuZn (Messing/brass)	Material of contact
Kontaktoberfläche	CuSnZn (Optalloy/optalloy), Sn (Zinn/tin)	Contact plating
Material Kontaktkörper	PA/PBT	Material of contact body
Material Gehäuse	PA/PBT	Material of housing

Montageanleitung
Assembly instruction

Abisoliermaße
Strip measures

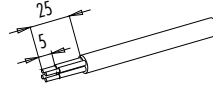

Einzelteildarstellung
Component part drawing

Kabeldose
Female cable connector

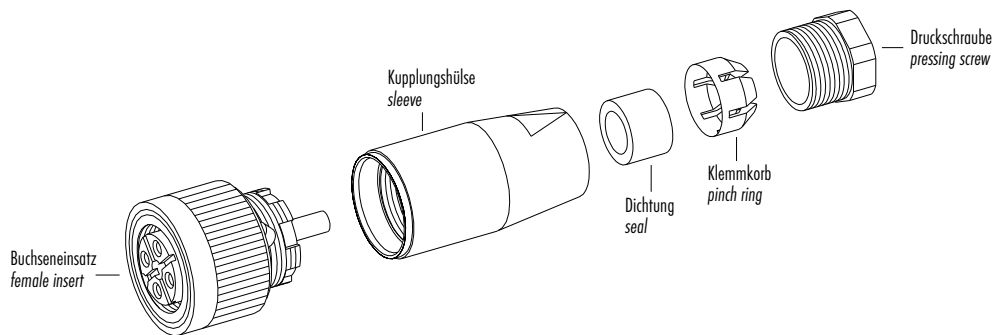

Winkeldose
Female angled connector

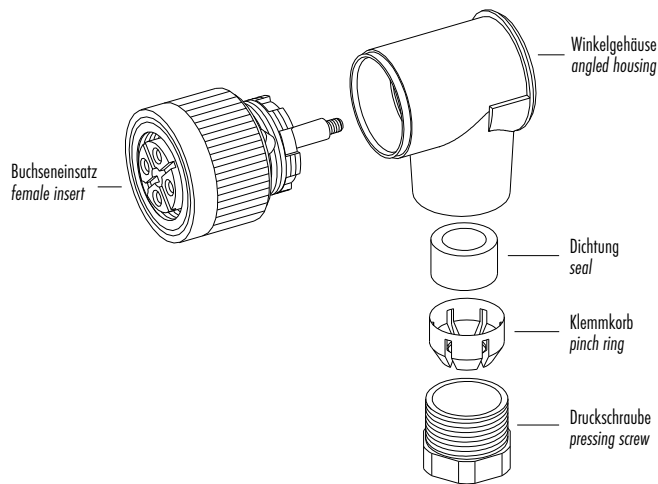

Polbilder
Contact arrangements

Stifteinsatz (Steckseite)
Male insert (mating side)

Buchseneinsatz (Steckseite)
Female insert (mating side)

4 pol
4 contacts

