



- Push-Pull locking system
- 3 – 19 contacts
- Degree of protection IP40/IP67
- Solder termination
- Diameter 20 mm
- Shieldable

Description	Drawing	Contacts	Cable outlet	Ordering-No.
Male cable connector, shieldable, IP67		3 DIN	4–8 mm	99 4805 00 03
		4		99 4809 00 04
		5		99 4813 00 05
		6 DIN		99 4817 00 06
		7		99 4825 00 07
		8 DIN		99 4829 00 08
		12		99 4833 00 12
		19		99 4841 00 19

Female cable connector, shieldable, IP67		3 DIN	4–8 mm	99 4806 00 03
		4		99 4810 00 04
		5		99 4814 00 05
		6 DIN		99 4818 00 06
		7		99 4826 00 07
		8 DIN		99 4830 00 08
		12		99 4834 00 12
		19		99 4842 00 19

	IP40	IP67	Shielded, IP67		
Male panel mount connector, IP40, IP67, shielded, IP67		3 DIN	09 4807 25 03	09 4807 15 03	09 4807 00 03
		4	09 4811 25 04	09 4811 15 04	09 4811 00 04
		5	09 4815 25 05	09 4815 15 05	09 4815 00 05
		6 DIN	09 4819 25 06	09 4819 15 06	09 4819 00 06
		7	09 4827 25 07	09 4827 15 07	09 4827 00 07
		8 DIN	09 4831 25 08	09 4831 15 08	09 4831 00 08
		12	09 4835 25 12	09 4835 15 12	09 4835 00 12
		19	09 4843 25 19	09 4843 15 19	09 4843 00 19

Male panel mount connector, front fastened, IP67, shielded, IP67		3 DIN	–	09 4807 80 03	09 4807 81 03
		4	–	09 4811 80 04	09 4811 81 04
		5	–	09 4815 80 05	09 4815 81 05
		6 DIN	–	09 4819 80 06	09 4819 81 06
		7	–	09 4827 80 07	09 4827 81 07
		8 DIN	–	09 4831 80 08	09 4831 81 08
		12	–	09 4835 80 12	09 4835 81 12
		19	–	09 4843 80 19	09 4843 81 19

Specifications

Contacts	3 DIN	4	5	6 DIN	7	8 DIN	12	19	
Wire gauge	max. 0,75 mm ² (max. AWG 20)						max. 0,25 mm ² (max. AWG 24)		
Mechanical operation	> 1000 Mating cycles								
Temperature range	– 40 °C / + 85 °C								
Rated voltage	250 V (32 V)			125 V (32 V)			60 V (32 V)		
Pollution degree	1 (2) ¹⁾								
Rated current (40°C)	7 A	6 A			5 A			3 A	
Contact plating	Ag (Silver)								
Material of housing	PA GF 25								

Description

Drawing

Female panel mount connector, IP40, IP67, shielded, IP67

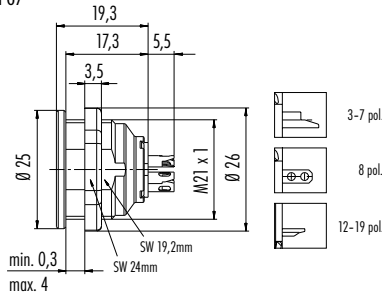

	IP40	IP67	Shielded, IP67
3 DIN	09 4808 25 03	09 4808 15 03	09 4808 00 03
4	09 4812 25 04	09 4812 15 04	09 4812 00 04
5	09 4816 25 05	09 4816 15 05	09 4816 00 05
6 DIN	09 4820 25 06	09 4820 15 06	09 4820 00 06
7	09 4828 25 07	09 4828 15 07	09 4828 00 07
8 DIN	09 4832 25 08	09 4832 15 08	09 4832 00 08
12	09 4836 25 12	09 4836 15 12	09 4836 00 12
19	09 4844 25 19	09 4844 15 19	09 4844 00 19

Female panel mount connector, front fastened, IP67, shielded, IP67

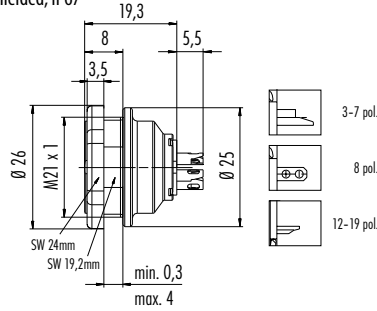

3 DIN	–	09 4808 80 03	09 4808 81 03
4	–	09 4812 80 04	09 4812 81 04
5	–	09 4816 80 05	09 4816 81 05
6 DIN	–	09 4820 80 06	09 4820 81 06
7	–	09 4828 80 07	09 4828 81 07
8 DIN	–	09 4832 80 08	09 4832 81 08
12	–	09 4836 80 12	09 4836 81 12
19	–	09 4844 80 19	09 4844 81 19

Component part drawing

Cable connectors

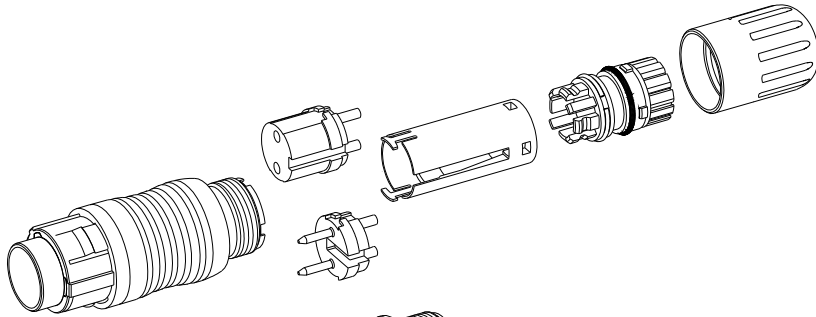

- Locking device
- Male insert
- Female insert
- Distance sleeve
- Clamping device
- Pressing screw

Panel mount connectors

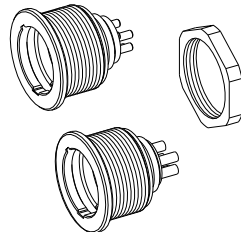

- Panel mount connector housing
- Female insert
- Male insert
- Hexagonal nut

Contact arrangements male insert (mating side)

3 DIN contacts

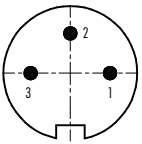

4 contacts

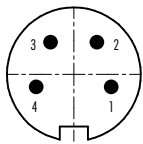

5 contacts

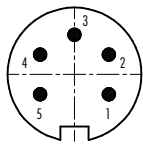

6 DIN contacts

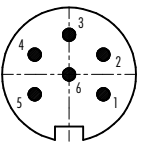

7 contacts

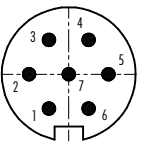

8 DIN contacts

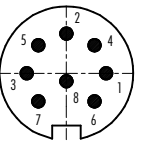

12 contacts

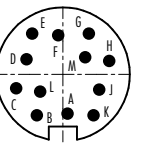

19 contacts

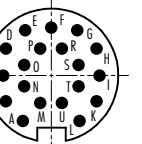

Contact arrangements female insert (mating side)

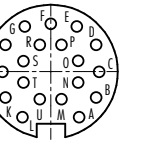
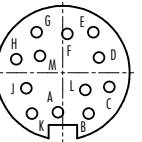
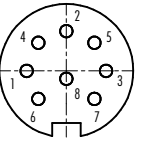
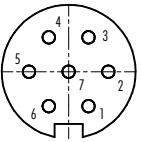
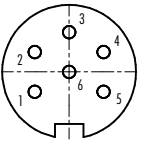
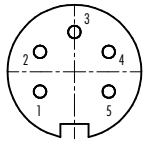
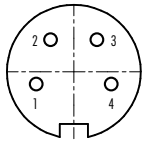
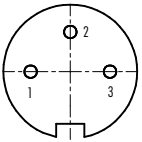

Panel cut out

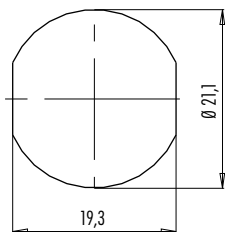

Description

Protection cap for cable connectors, IP67

Drawing

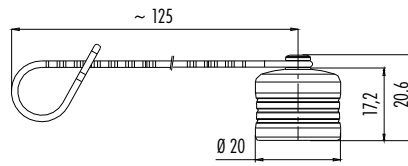

Ordering-No.

08 2605 000 001

Protection cap for panel mount connectors, IP67

Hole-Ø D

3 mm 08 2604 000 001
21 mm 08 2679 000 001

Ordering-No.

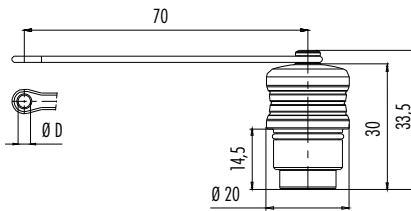

Protection cap for panel mount connectors, IP40

Ordering-No.

08 2603 000 000

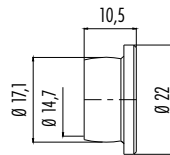

Adapter for a cable-cable connection to mate a panel mount connector

Cable outlet

4-6 mm/6-8 mm 08 2606 000 001

Ordering-No.

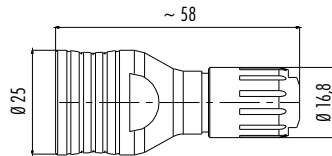

Sealings enclosed loose